

ROOFING TECHNOLOGY



Why do we need to be concerned about roofs?

- Roof and membrane failures are the most often litigated parts of a building
- good detailing is paramount
- never use materials or systems that have not been “approved” or tested by a reputable agency

GENERAL ROOFING TERMS

FROM THE INTERNATIONAL LIBRARY OF TECHNOLOGY, 33C, 1909

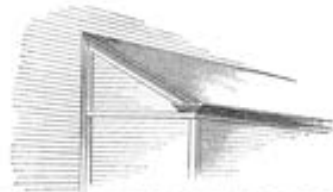

SHED, PENT OR LEAN-TO ROOF



MANSARD ROOF



LOUVRE
VENTILATOR



GABLE ROOF



OGEE ROOF



SURMOUNTED DOME



CURB OR
GAMBREL ROOF



SEMICIRCULAR DOME



HIP ROOF



SEMICIRCULAR OR
BARREL ROOF



ELLIPSOIDAL DOME



HIP AND VALLEY ROOF



SEGMENTED DOME



DORMER
WINDOW



BELL
DOME



GRECIAN PITCH



ROMAN PITCH



A SQUINT



EYEBROW DORMER

ELIZABETHAN PITCH



GOthic PITCH

It is important to be familiar with the general roofing terms regarding their general shape and configuration.

ROOFING TYPES:

THE TWO PRIMARY TYPES OF ROOFING WE MUST CONSIDER ARE **FLAT** AND **PITCHED**:

Flat roofs are those slope is **LESS THAN 1 in 4** and use waterproof membranes (also called Low Slope)

Pitched roofs have slopes of **1 in 4 or GREATER** and generally use shingles

Roof Type Selection

- Depends on building use
- Span
- Structural materials
- Need to shed water or snow
- Need to provide overhangs for shading
- Need to provide overhangs to protect the wall materials
- Need for insulation (and type of insulation to be used - batt vs foam/rigid)
- Incorporation of skylights or roof glazing

Common Fact

- Flat roofs are prone to leaking
- Leaks are difficult to find as the entry point for the leaking water is usually not near the point of apparent leakage
- Sloped roofs tend to stay watertight if properly built (pay attention to ice dams...)

Pitched Roof Materials:

SHINGLES:

- asphalt, sawn wood, shakes, slate, clay tiles or concrete tiles

THATCH:

- bundles of leaves, reeds or grasses

ARCHITECTURAL SHEET METAL:

- lead, copper and terne (stainless steel or sheet steel) with flat or standing seams

Terne is an alloy coating that was historically made of lead and tin used to cover steel, in the ratio of 20% tin and 80% lead. Currently, lead has been replaced with the metal zinc and is used in the ratio of 50% tin and 50% zinc.



Traditional roofing types



Traditional
thatched roof





"old" vs. "new" slate



Slate is typically installed over wood slats rather than plywood sheathing.





The life span of an asphalt-shingle roof shingles is somewhere between 15 and 30 years, depending on the quality of the roofing shingles and the climate in your region. Wind can often cause as much damage as water, cold temperatures and sun.

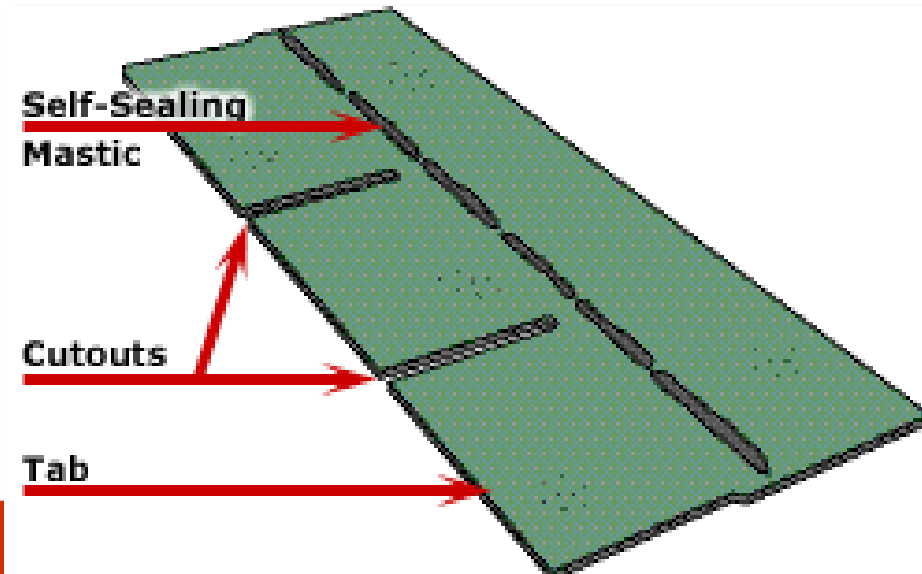

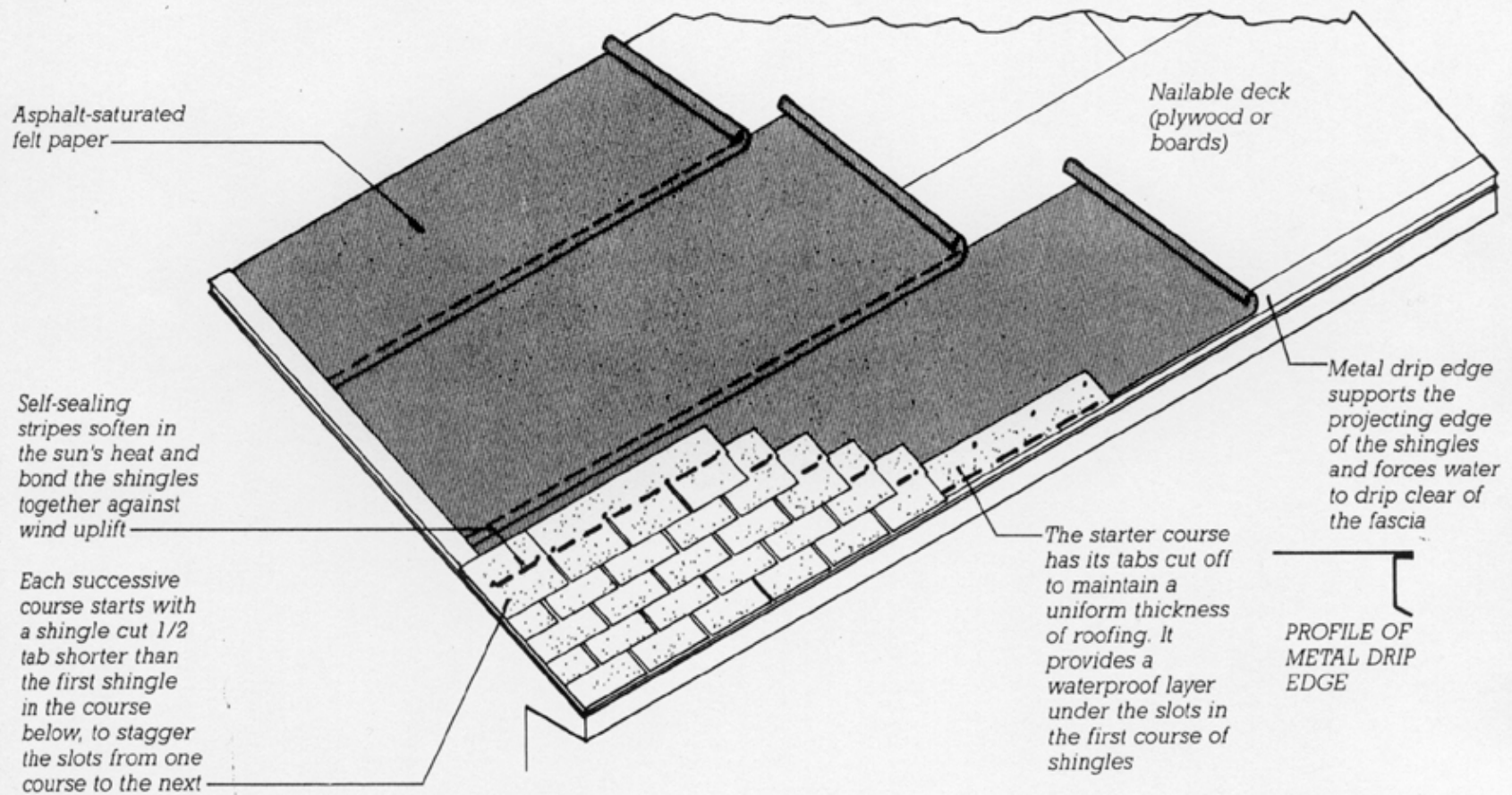

FIGURE 13.42

Starting an asphalt shingle roof. Most building codes require the installation of a snow-melt barrier beneath the shingles at the eave in regions with cold winters. The most effective form of barrier is a 3-foot-wide (900-mm)

strip of modified bitumen sheet that replaces the lowest course of asphalt-saturated felt paper. The bitumen self-seals around the shanks of the roofing nails as they are driven through it.

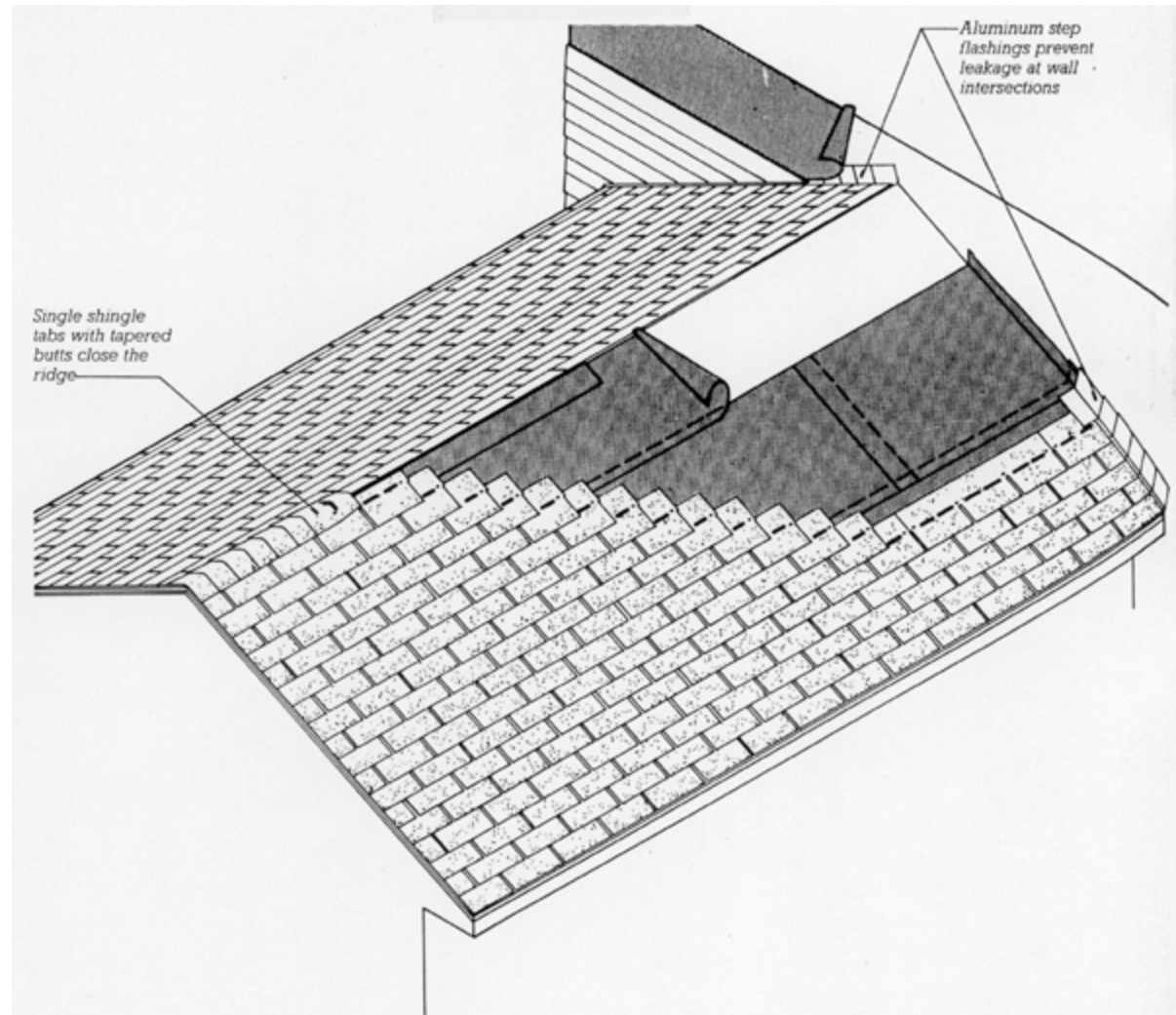
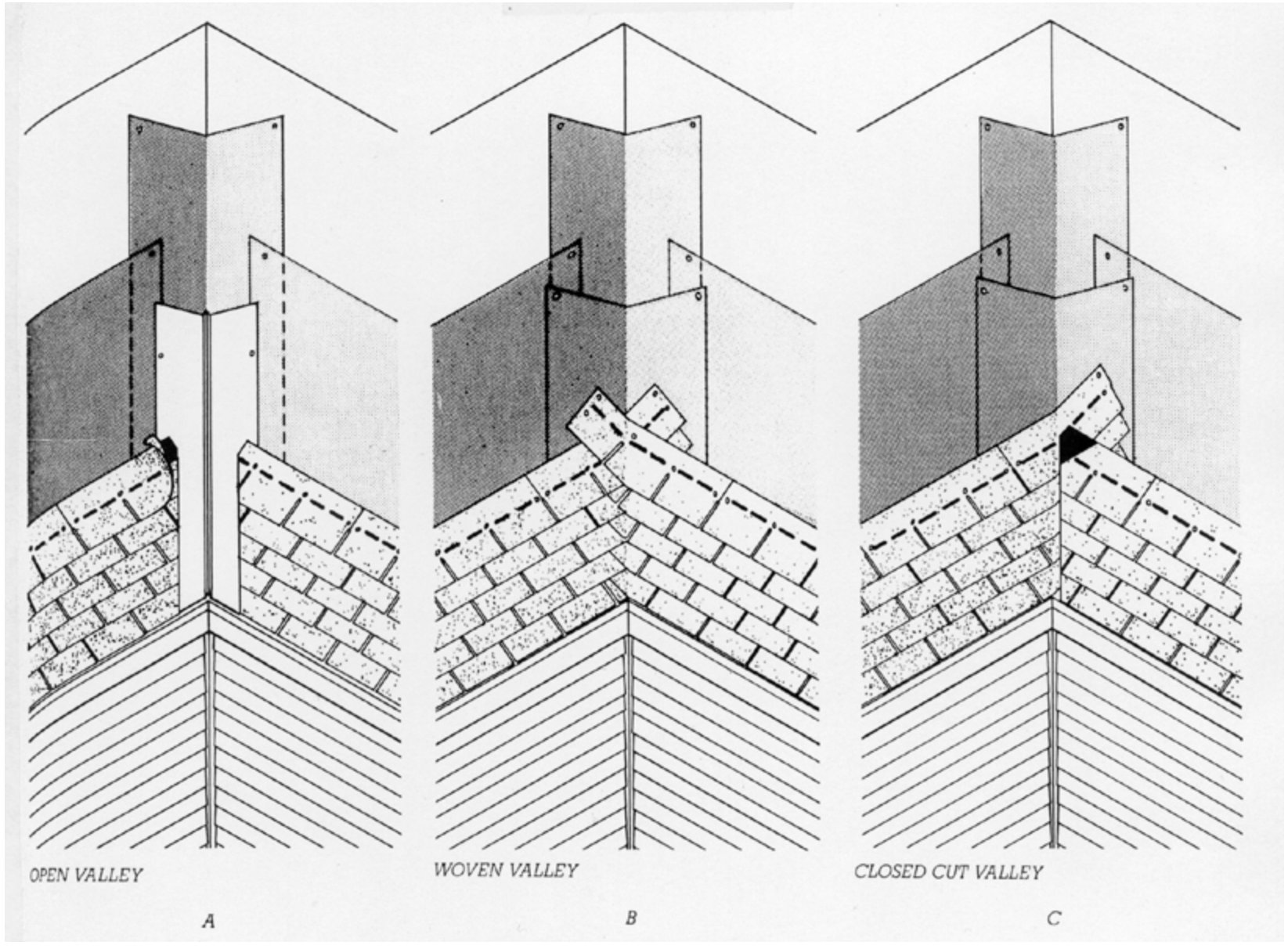

FIGURE 13.43
Completing an asphalt shingle roof. A metal attic-ventilation strip is often substituted for the single-tab shingles on the ridge.

Pitched Roof: Shingle Ridge Detail



Pitched Roof: Shingle Valley Detail

CLOSED CUT VALLEY

DIAGRAM 1

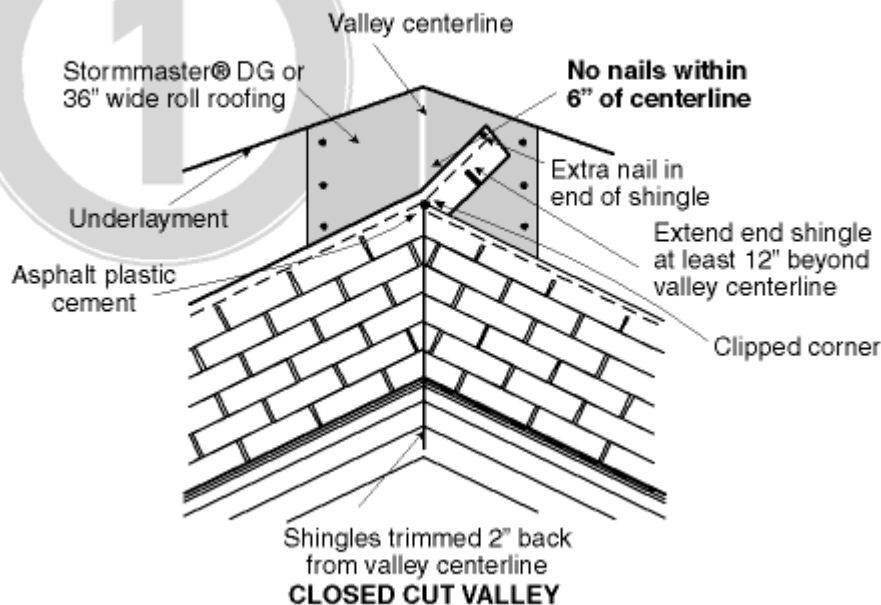

WOVEN VALLEY

DIAGRAM 2

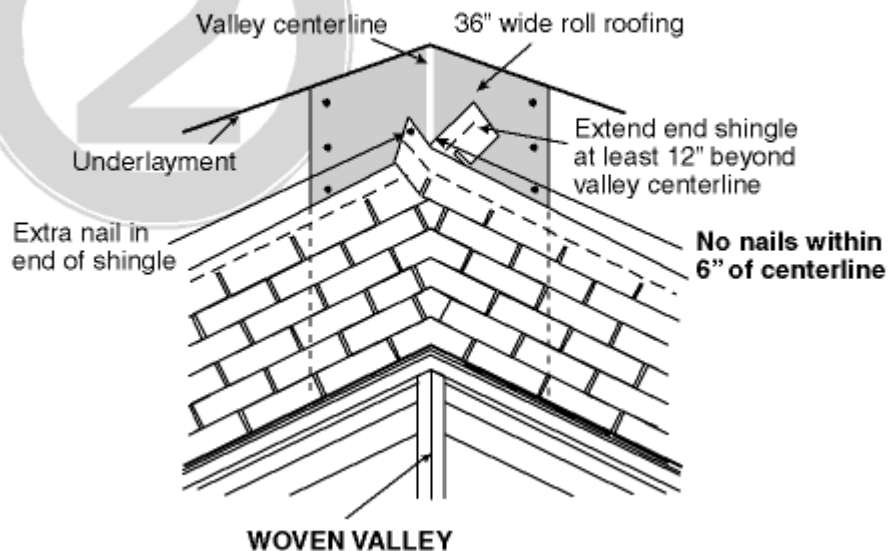

OPEN VALLEY

DIAGRAM 3

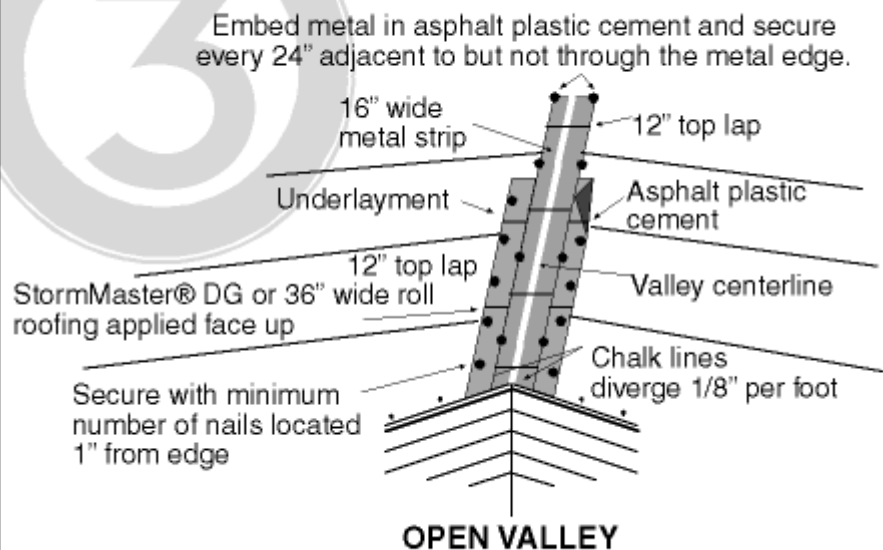

STARTER COURSE

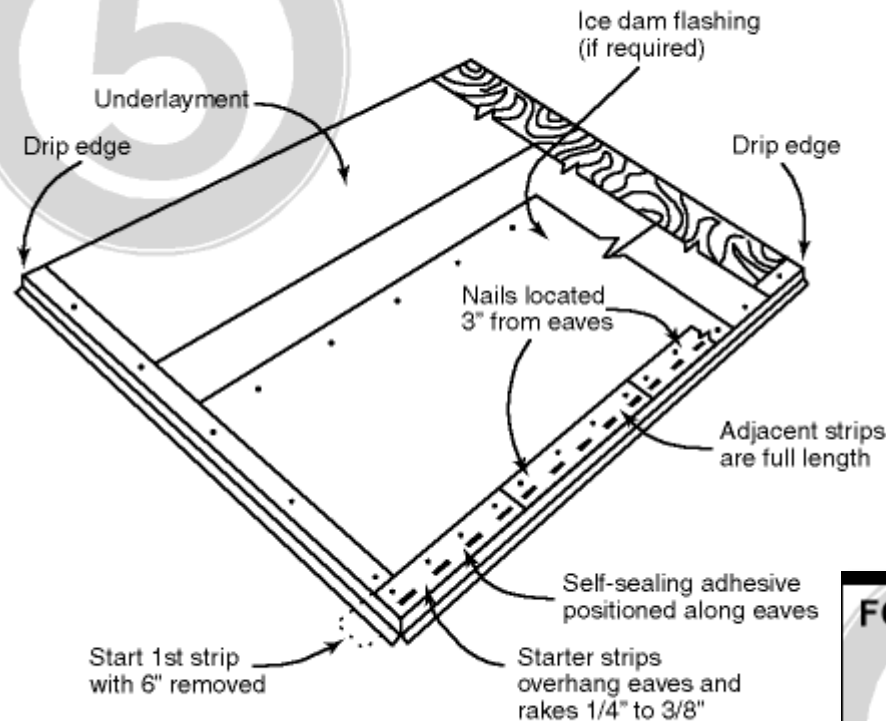

FOURTH COURSE

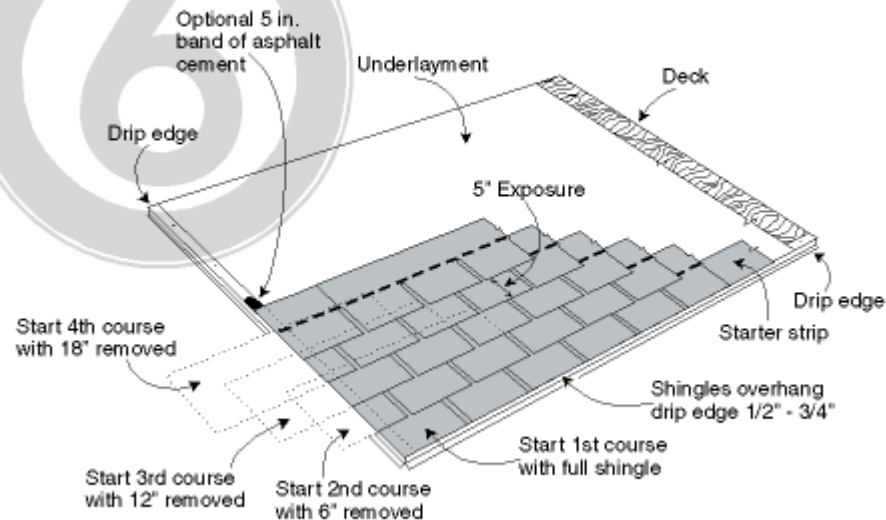

CEMENT APPLICATION

DIAGRAM 7

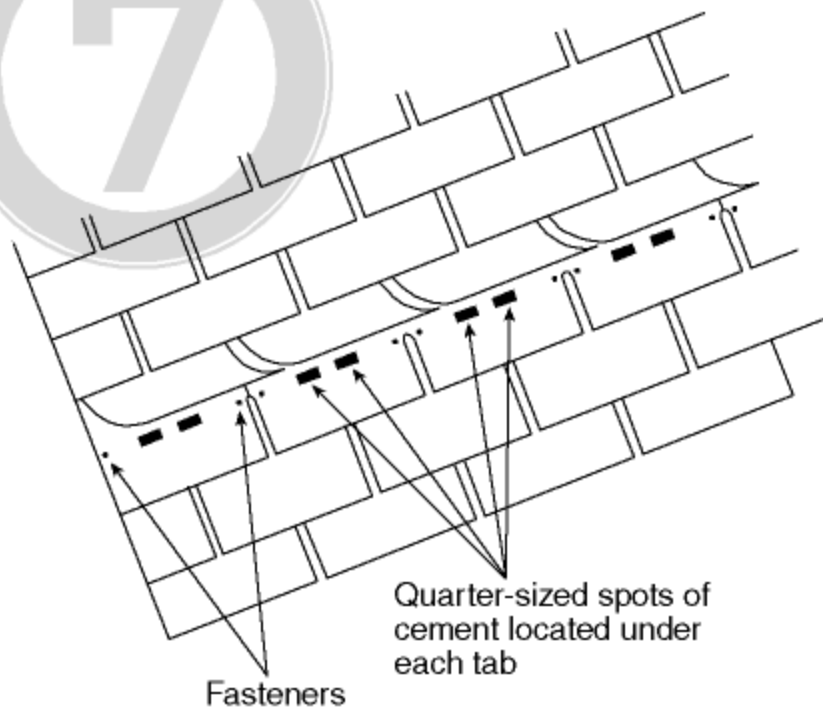

FASTENER LOCATIONS

DIAGRAM 4

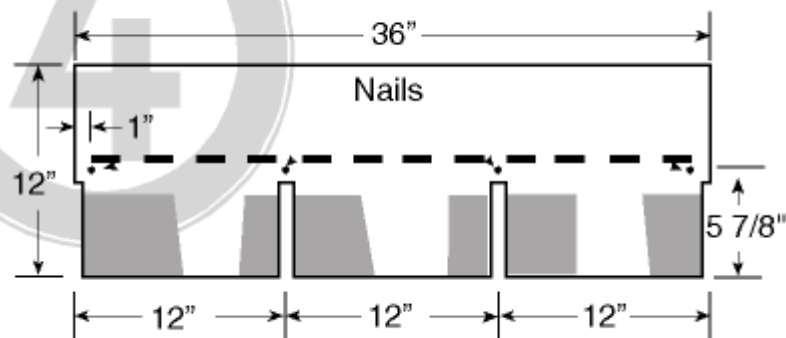

HIP & RIDGE

DIAGRAM 8

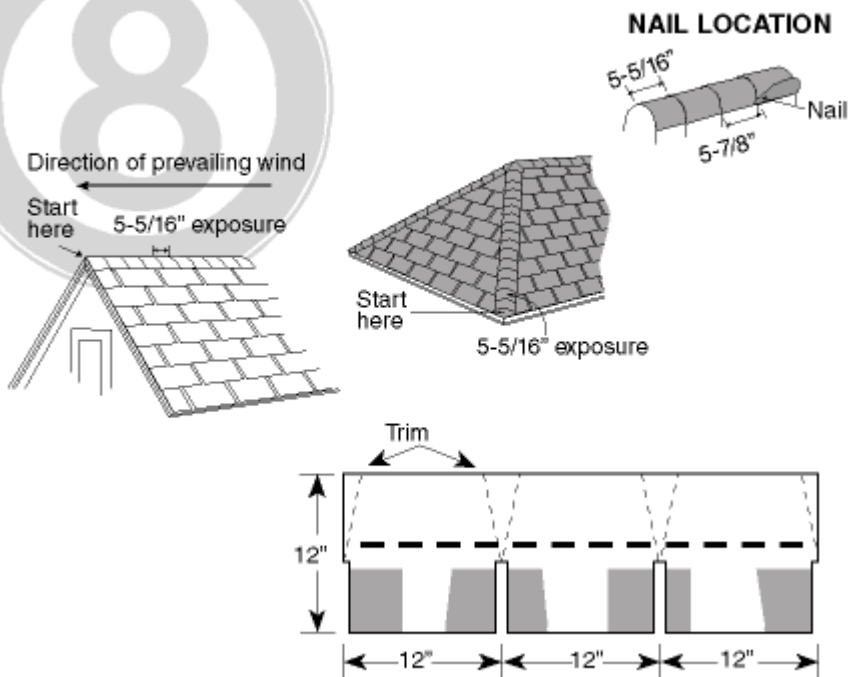

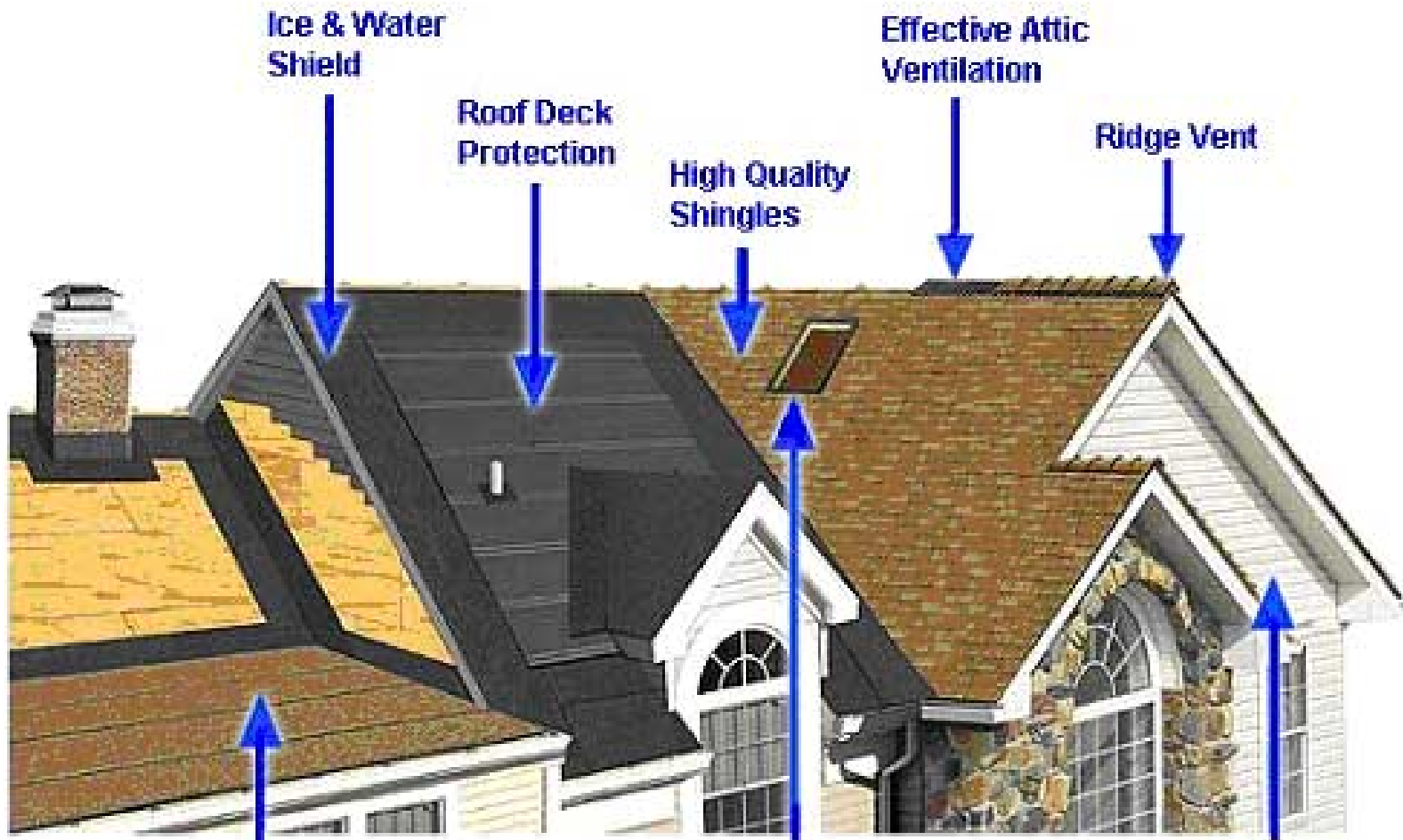

Ice & Water Shield

Roof Deck Protection

High Quality Shingles

Effective Attic Ventilation

Ridge Vent

Rubber Membrane

We Install Replacement Windows And Skylights!

We Install Wood & Fiber Cement Siding!



Ice and water shield being installed at the bottom meter of a shingled roof. Note that it is lapped UNDER the roofing paper to promote drainage. This extra membrane is thicker and more durable than roofing paper and is meant to prevent water leakage due to "ice dams" at the end of the roof.

Eave protection against ice dams

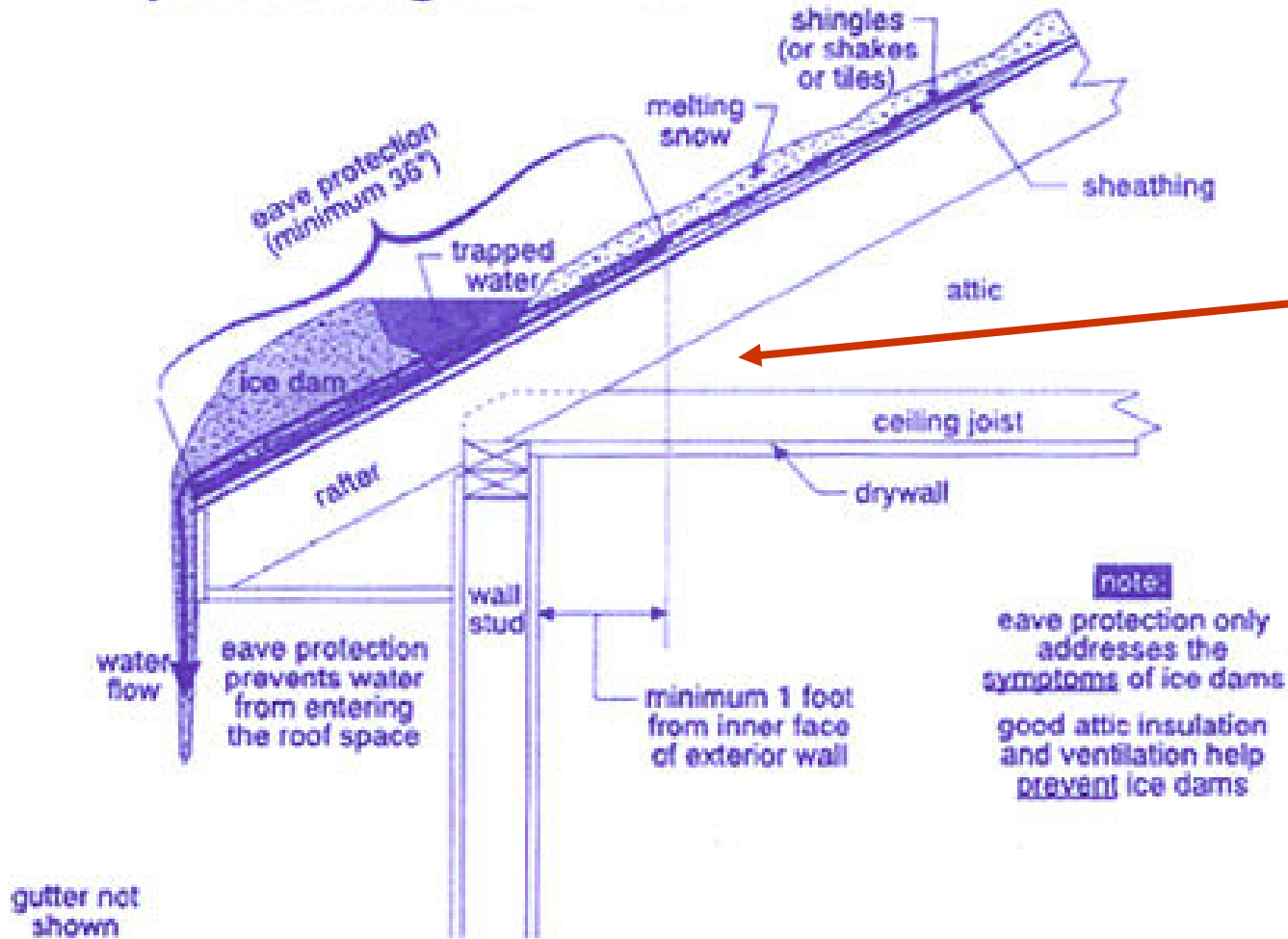

Figure 5. Ice Damming

Roof felt

Shingle line

Vent pipe flashing

Valley flashing

Drip edge

**Chimney base
flashing**

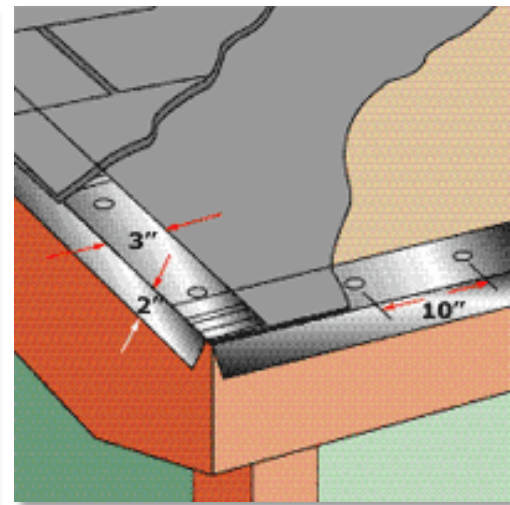
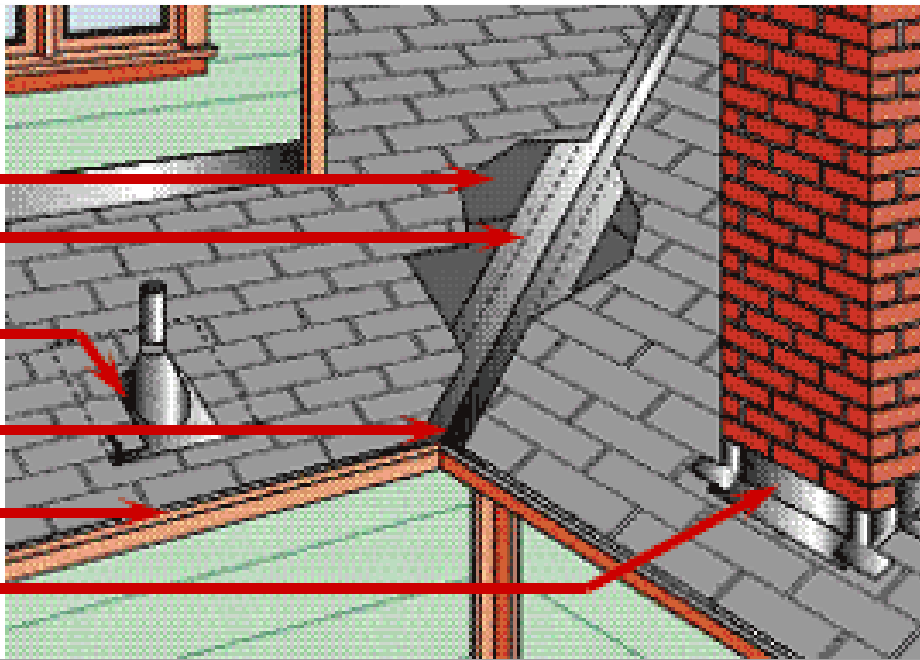

**Cap flashing (shown
bent upward)**

Mortar joints

Step flashing

Cap flashing

Base flashing

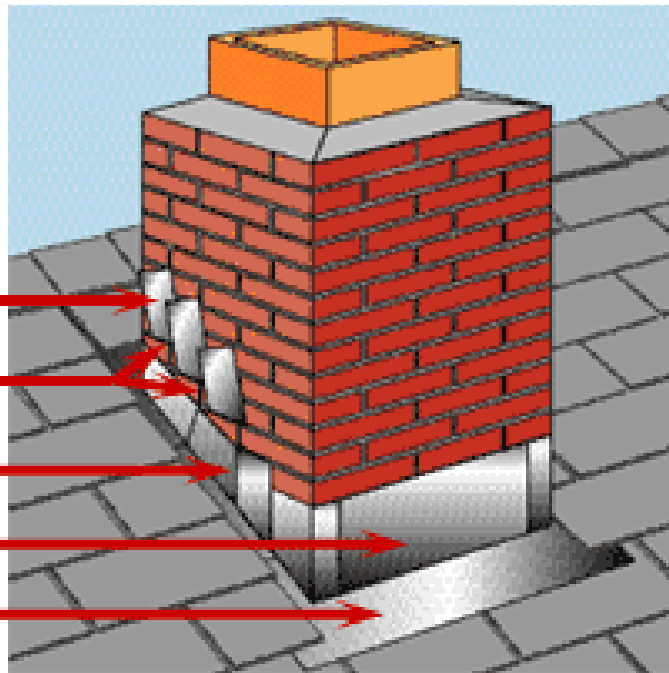

Ashphalt
flashing details



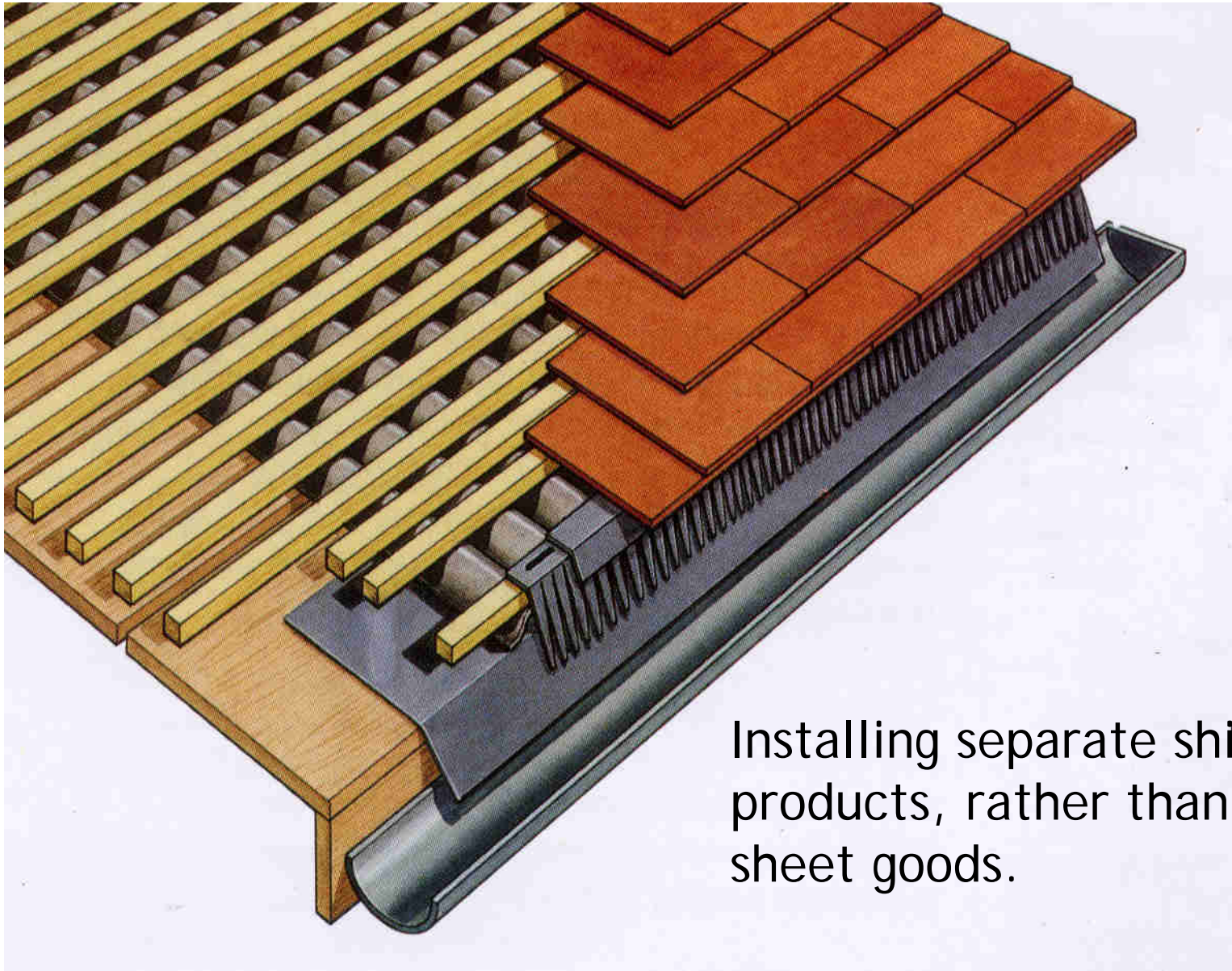

Installing separate shingle products, rather than sheet goods.

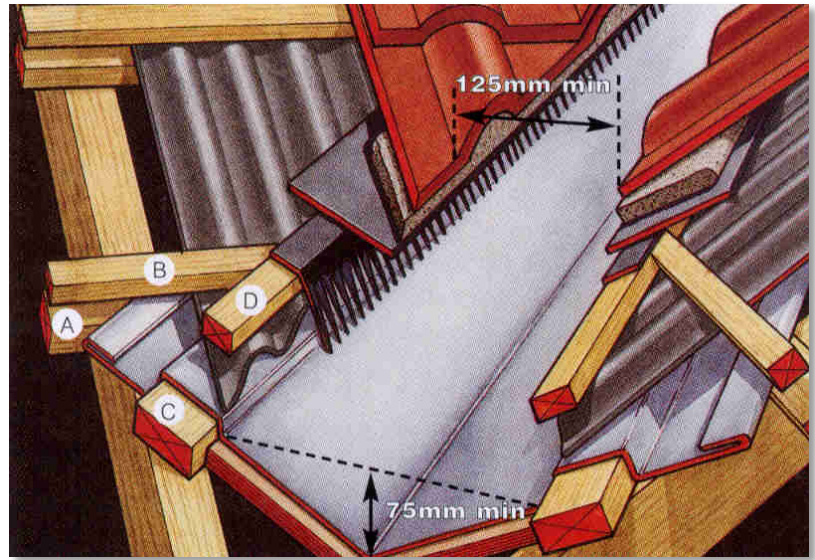
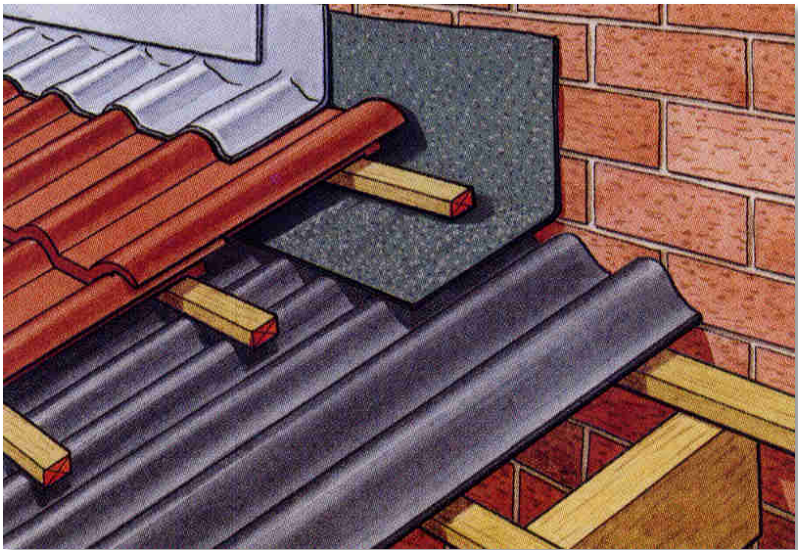
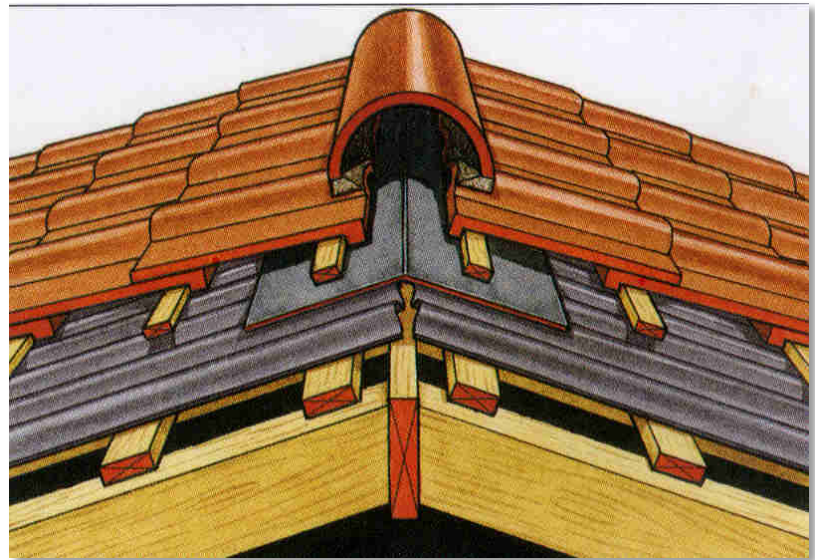
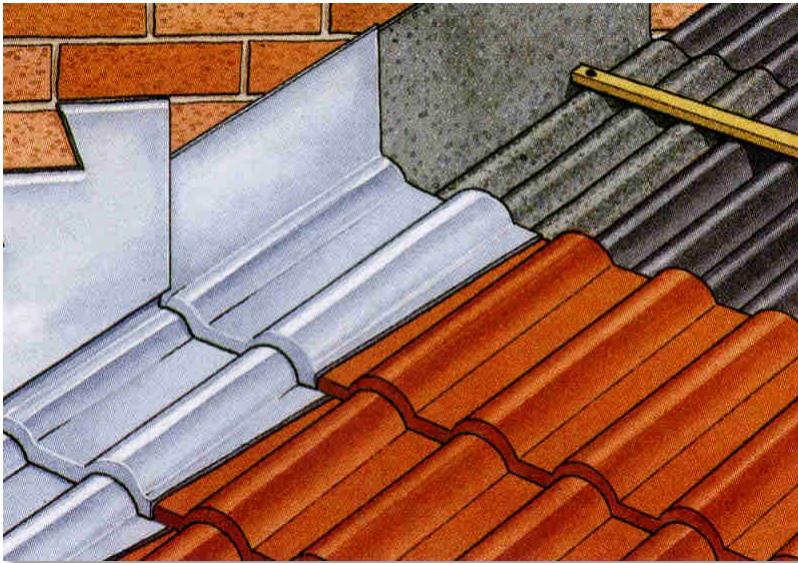

Installation details for tile products.

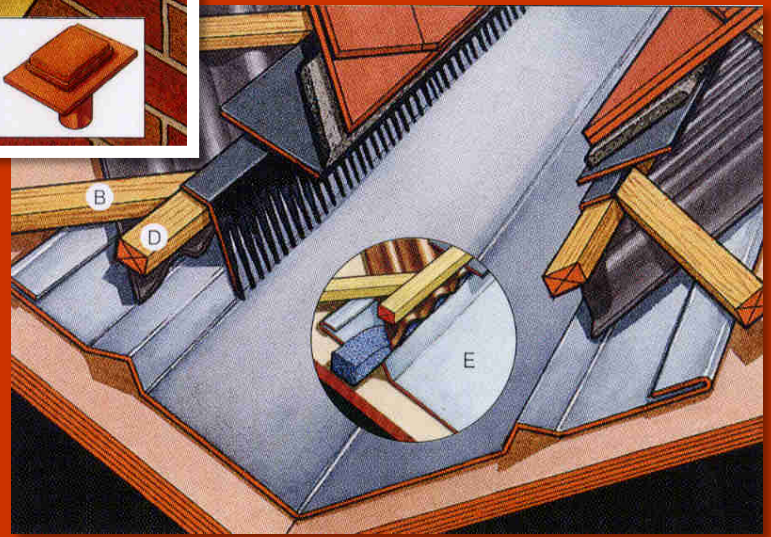
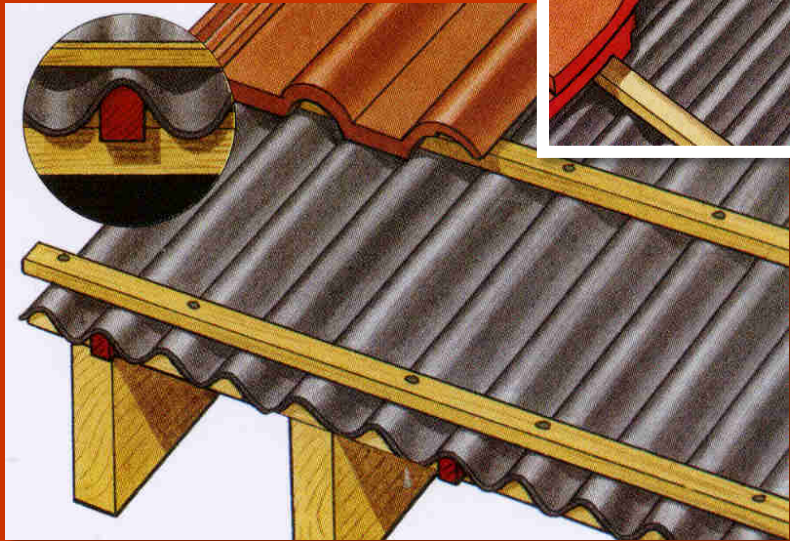
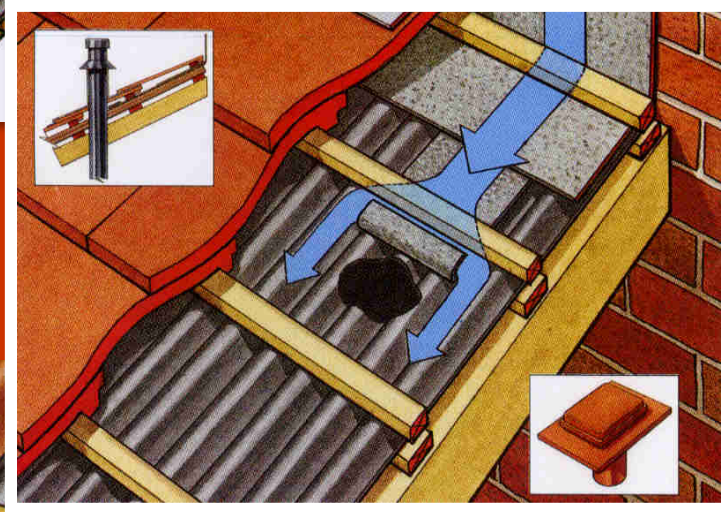
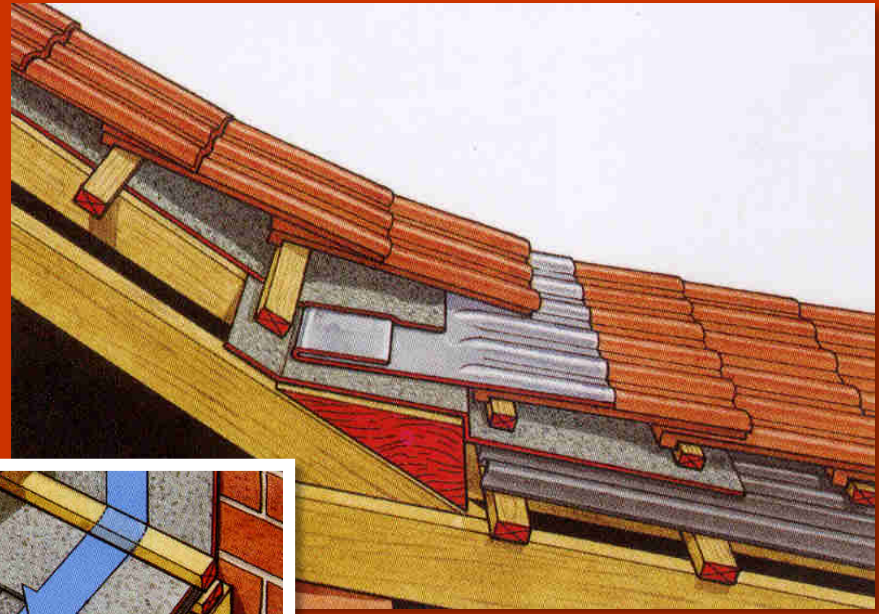
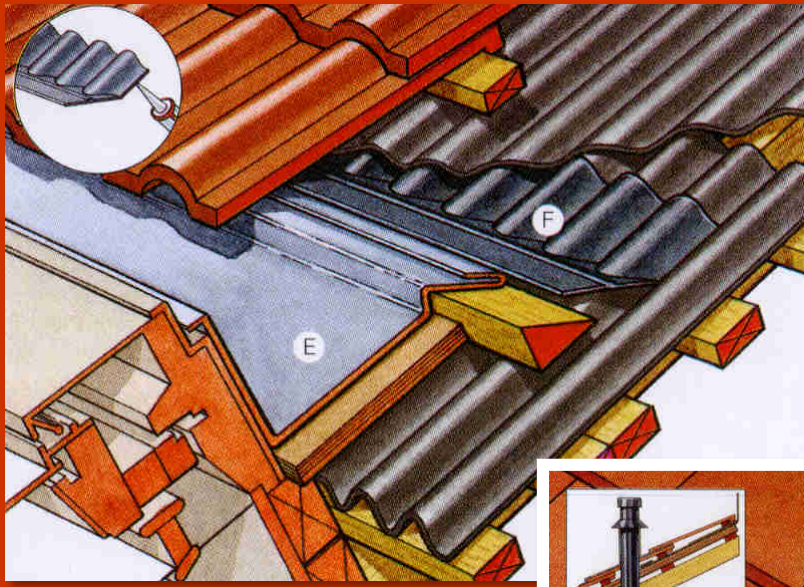



Contemporary tile look roof with underlayment



Larger sheet product







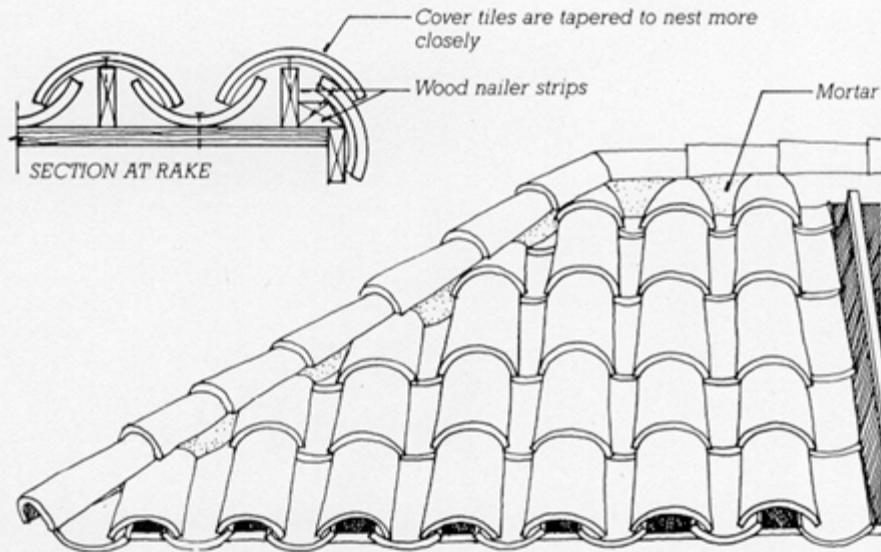
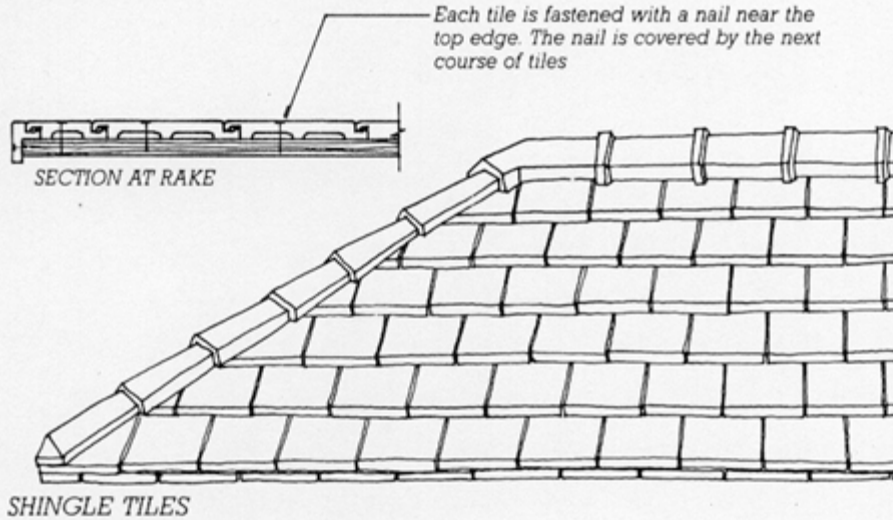

FIGURE 13.47
Two styles of clay tile roofs. The mission tile has very ancient origins.



Pitched Roof: Clay Tiles





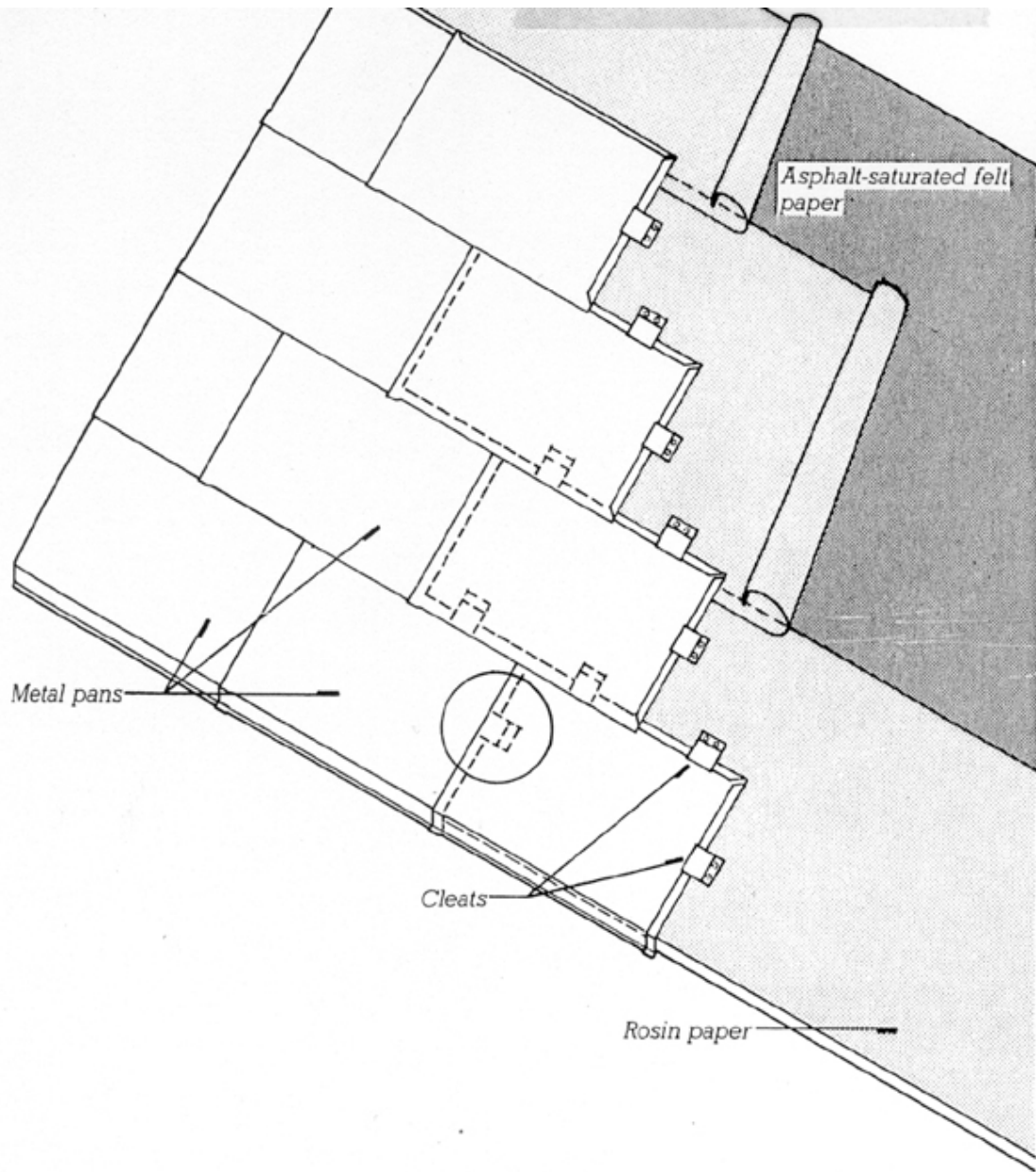
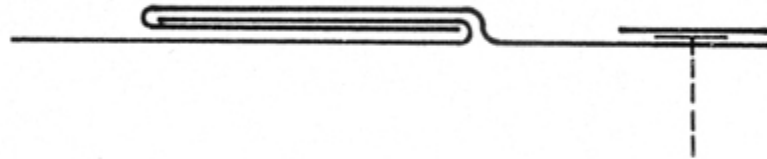

FIGURE 13.50
Installing a flat-seam metal roof. The three diagrams at the bottom of the illustration show the three steps in creating the seam, viewed in cross section. The cleats, which fasten the roofing to the deck, are completely concealed when the roof is finished.



Step 1: Each pan is formed in the sheetmetal shop with folded edges.



Step 2: Sheet metal cleats interlock with the folded edges and are nailed to the deck. The cleat is folded back over the nail head to protect the pan.

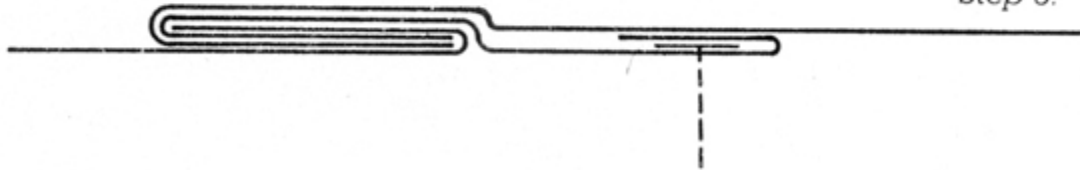

Step 3: The next pan is interlocked with the first. When all pans are in place, the edges are beaten flat and soldered or sealed.

Metal Roof: Flat Seam





ArchitectureWeek.com

In projects such as Gehry's EMP in Seattle, the use of metal cladding blurs the distinction between what is the wall and what is the roof.

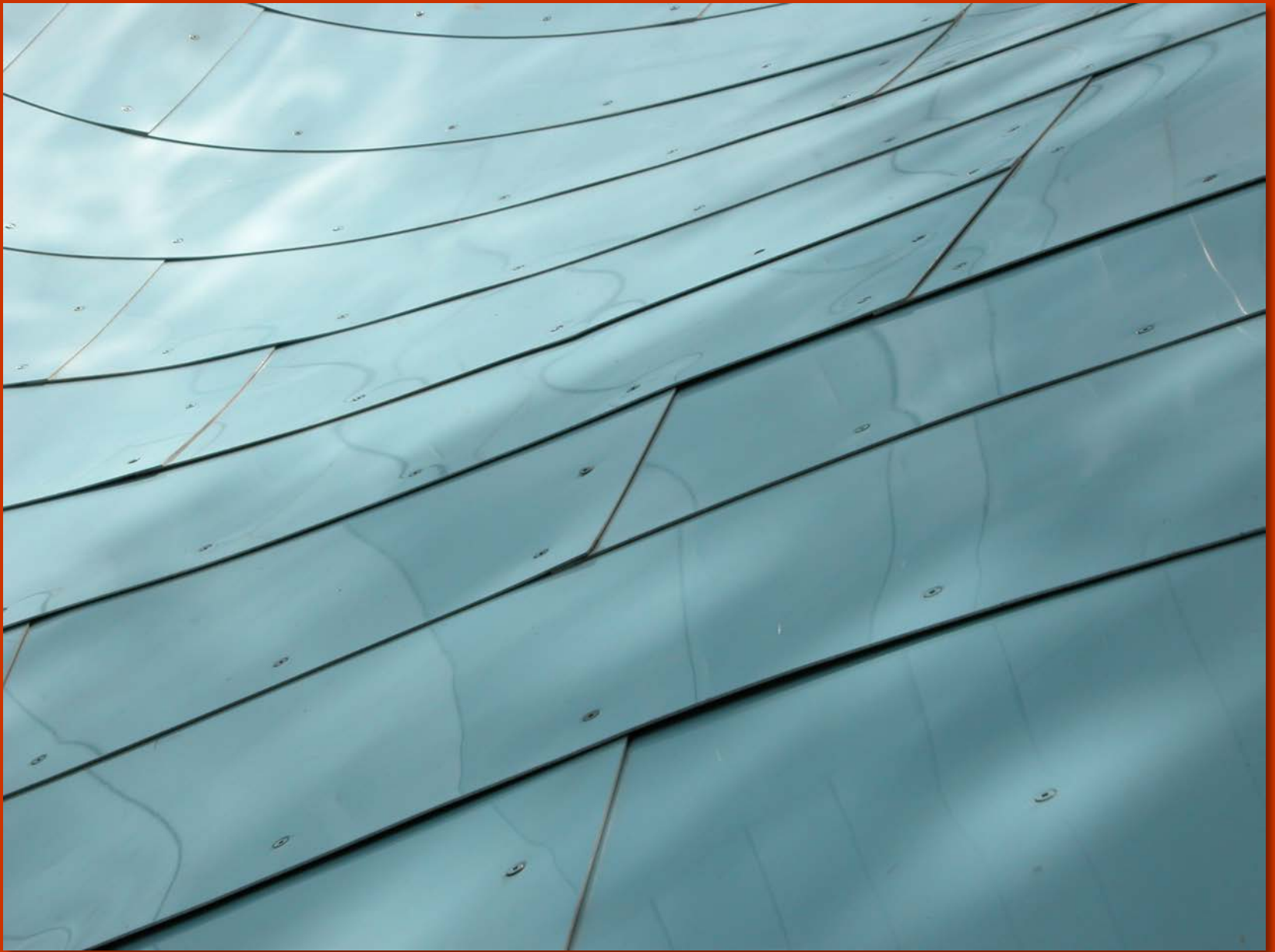





The Gehry Weisman Art Museum in Minneapolis used similar techniques for the stainless steel cladding panels.



The Gehry Weisman Art Museum in Minneapolis used similar techniques for the stainless steel cladding panels.



Although here you can see for the flat window ledge detail that a sealant has been used to prevent water penetration. NOT the best solution! Slope to drain is ALWAYS more reliable

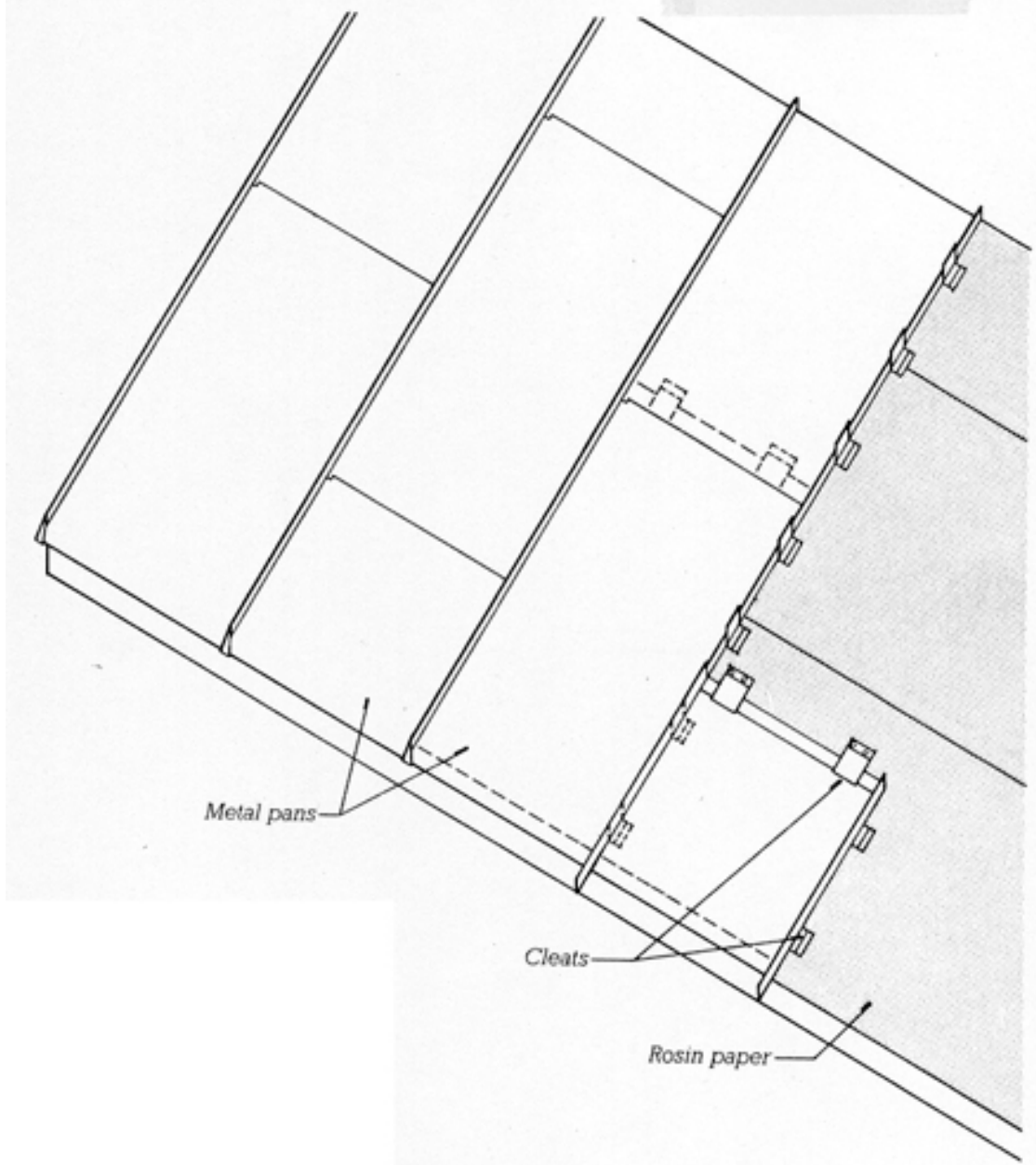
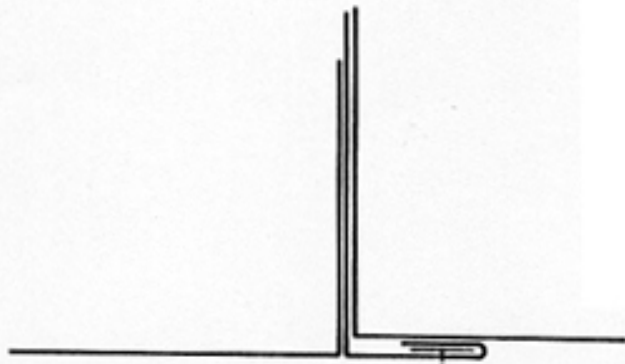
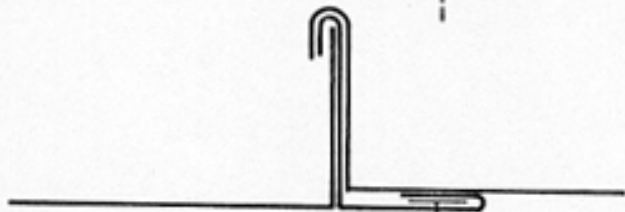

FIGURE 13.51
Installing an architectural standing-seam metal roof.

Metal Roof: Standing Seam



Step 1: The nailed cleat and pans are aligned.



Step 2: The edges of the pans and the cleats are rolled together into a standing seam.

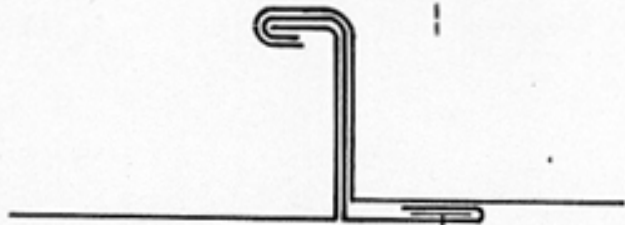

Step 3

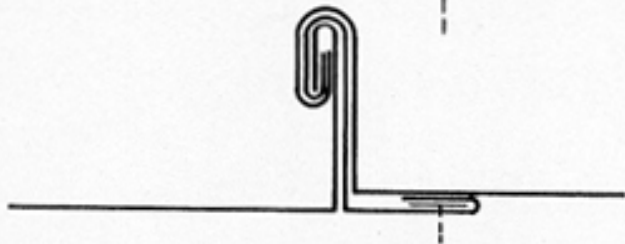

Step 4

Metal Roof: Standing Seam



Traditional Quebec roofs (don't use shingles)







Standing seam metal roof



Contemporary terne-look roof in standing seam

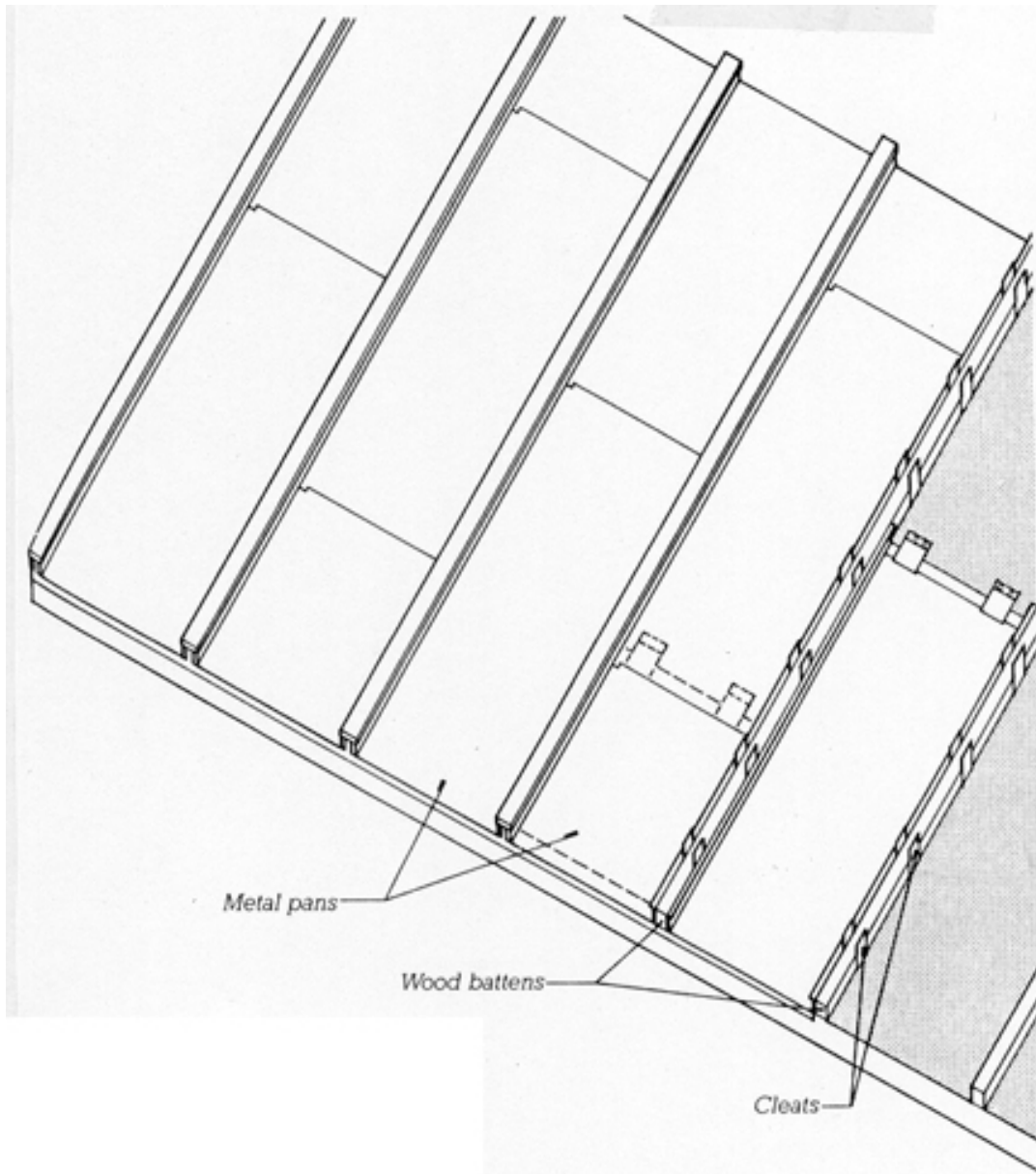
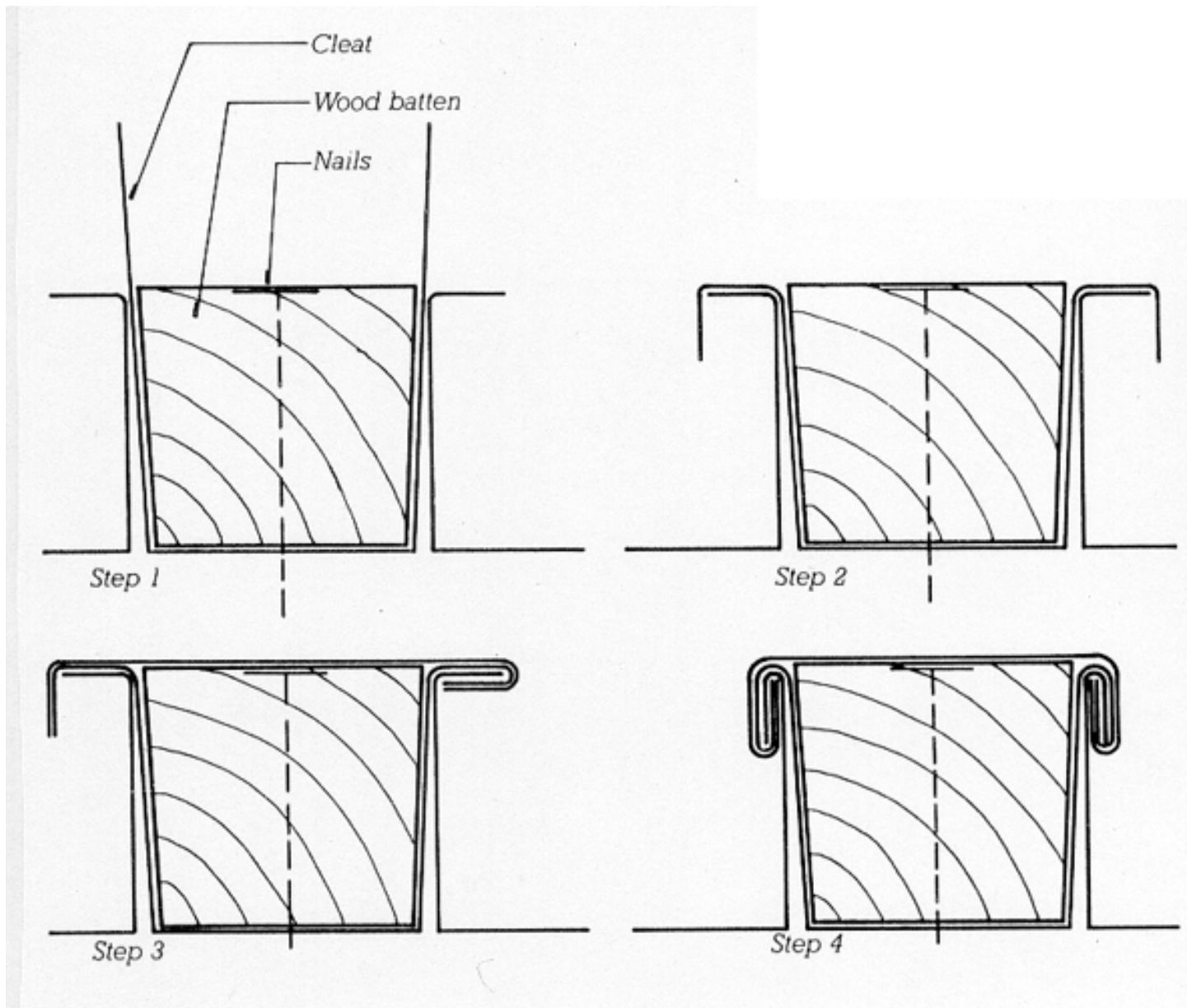

FIGURE 13.52

Installing a batten-seam metal roof. The battens are tapered in cross section to allow for expansion of the roofing metal.

Aluminum
 Zinc and galvanized steel
 Chromium
 Steel
 Stainless steel
 Cadmium
 Nickel
 Tin
 Lead
 Brass
 Bronze
 Copper

Metal Roof: Blocked Seam



Metal Roof: Block Seam

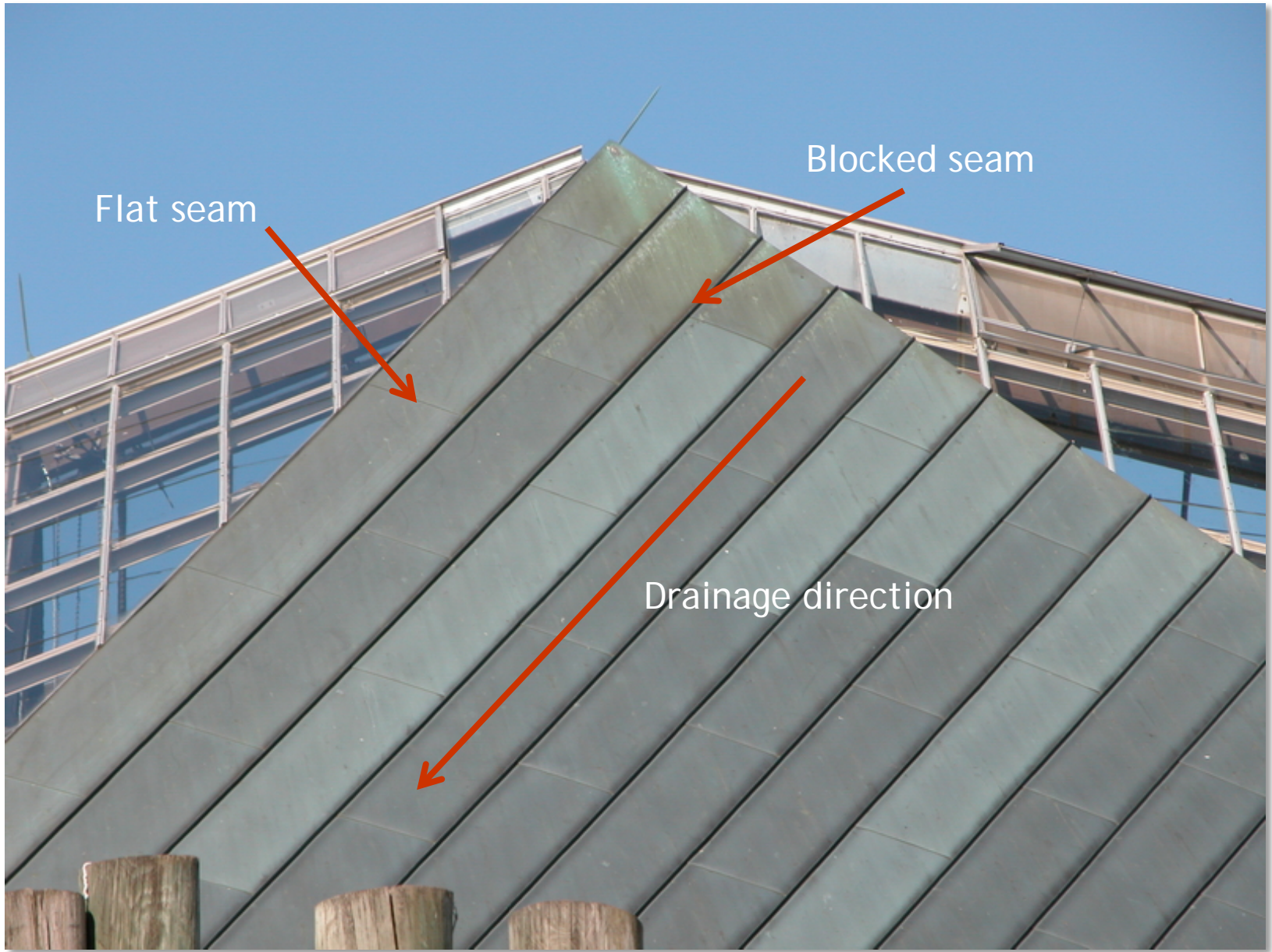

Toronto Zoo



This is a metal roof with a snow dam at the edge. This is required to stop snow from sliding off the roof and on to the people below.



Snow guards at the edge of roofs



LOADING AREA

LOADING AREA

TOOL RENTAL CENTRE

PLEASE
LOAD
HERE
←←←

KMK

Propane

EXT

HOME DEPOT



ONTARIO'S HOME IMPROVEM

able
itchens Blinds

APPLY
HARVEY'S
CHARGE
CARD
TODAY!



YOU FIND
W

Flat or Low Slope Roofs:

PRIMARY COMPONENTS:

- structural roof deck
- thermal insulation
- vapour retarder (and air barrier)
- waterproof membrane



Structural Roof Deck:

- must be designed to *minimize deflection* to reduce ponding and minimize drainage
- either slope the roof deck or taper the insulation to drain roof
- usual materials are:
 - plywood
 - wood decking
 - cast or hollow core concrete
 - steel decking

(choice depends on building type, fire rating and primary structural system)

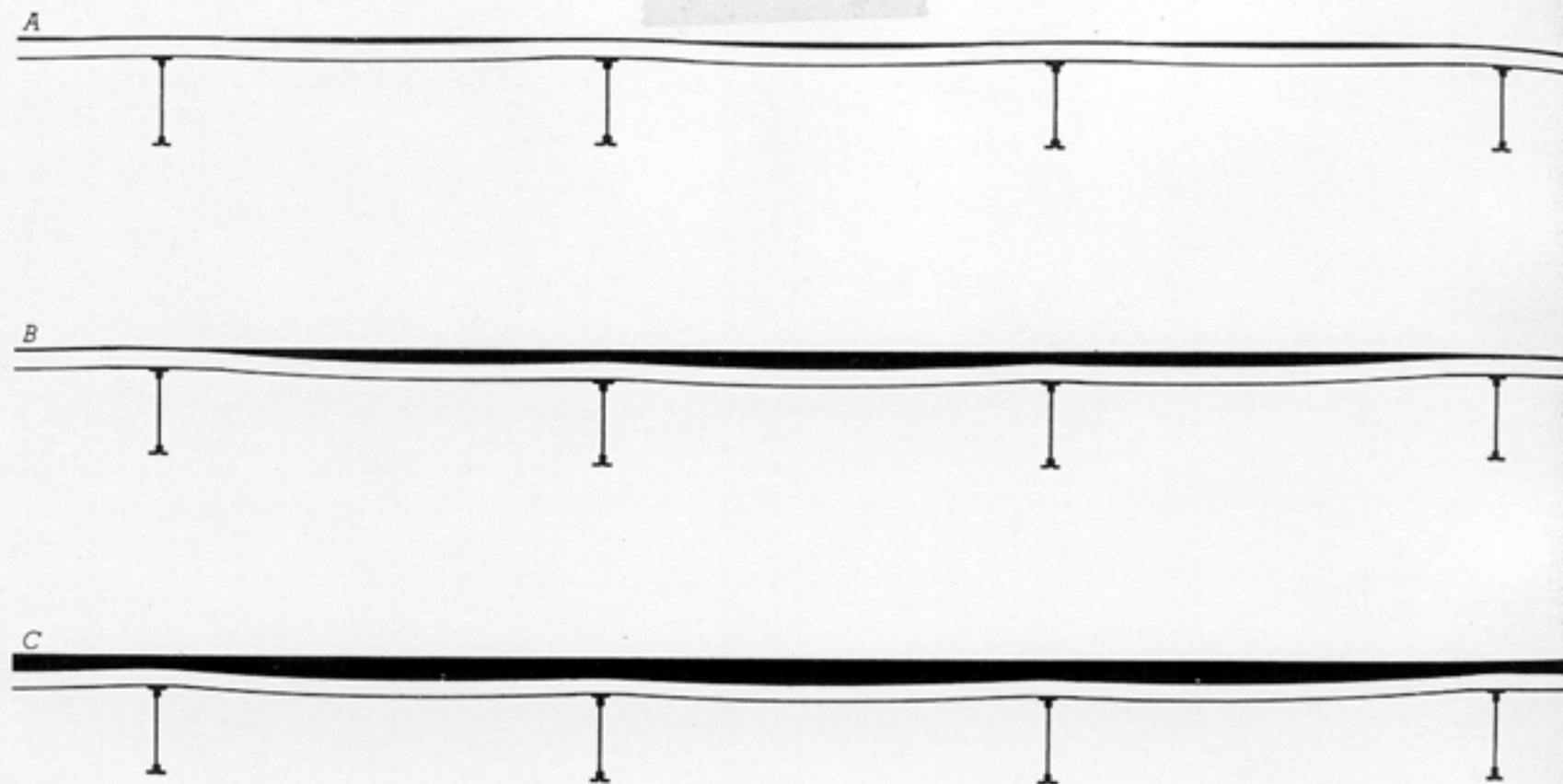

FIGURE 13.3

A low-slope roof with insufficient pitch to drain is subject to structural failure through progressive collapse, as demonstrated in this sequence of cross sections: (a) Water stands on the roof in puddles, causing slight deflections of the roof deck between supporting beams or joists. (b) If heavy rainfall continues, the puddles grow and join, and the accumulating

weight of the water begins to cause serious deflections in the supporting structural elements. The deflections encourage water from a broader area of the roof to run into the puddle. (c) As structural deflections increase, the depth of the puddle increases more and more rapidly, until the overloaded structure collapses.



Roof collapse in Poland due to excessive snow loading

Thermal Insulation:

Can be installed in THREE positions:

- **BELOW** the deck
- **BETWEEN** the deck and the membrane
- **ABOVE** the membrane



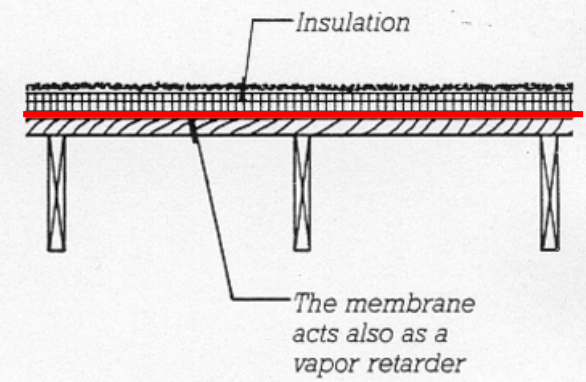
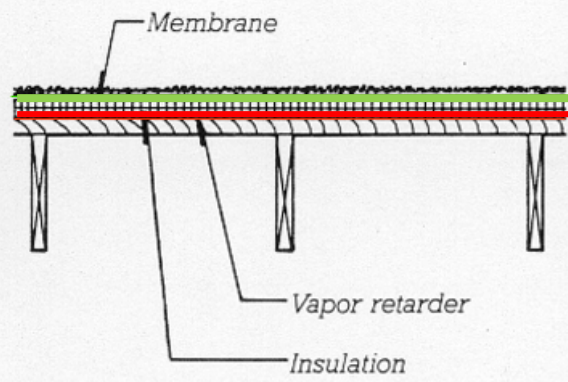
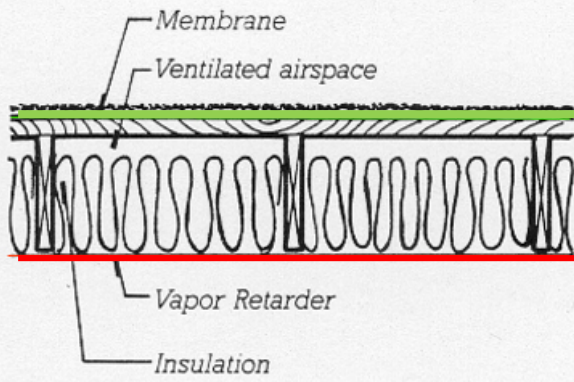

FIGURE 13.4

Low-slope roofs with thermal insulation in three different positions, shown here on a wood joisted roof deck. At left, insulation below the

deck, with a vapor retarder on the warm side of the insulation. In the center, insulation between the deck and the membrane, with a vapor re-

tarder on the warm side of the insulation. At right, a protected membrane roof, in which the insulation is above the membrane.

A vented air space is mandatory when using batt insulation in a flat roof!!

If you use rigid polystyrene insulation (the blue kind) or a foamed in place closed cell type, no air space is necessary as it is waterproof.

Flat Roof: Insulation and Membrane Position

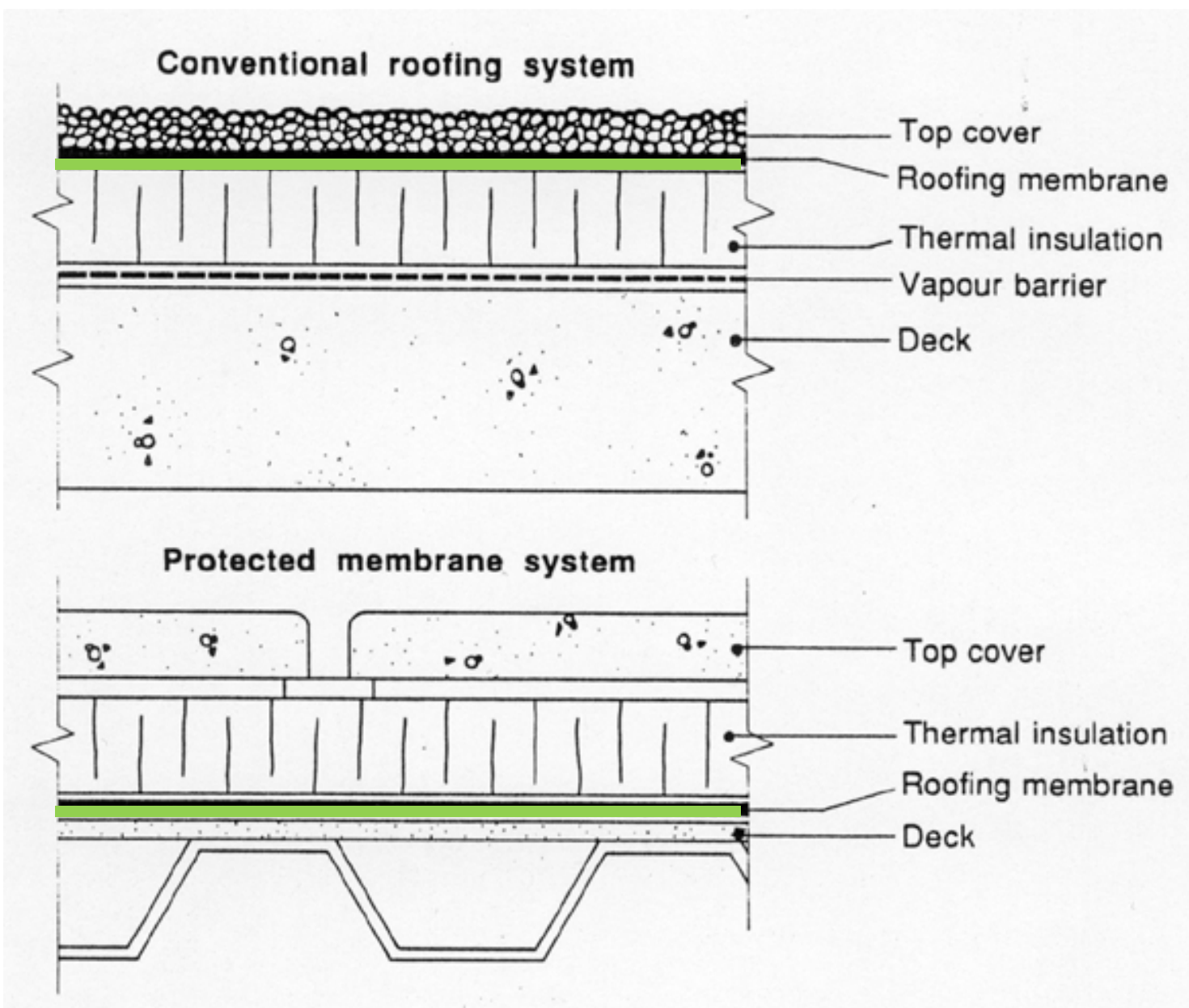

Flat Roof: BUR (traditional) vs. Inverted (newer methodology)

Insulation BETWEEN Membrane and Deck:

Traditional location for insulation:

- use low density rigid panels to support the loads on the roof membrane without allowing puncture of membrane
- any water vapour trapped in insulation will cause deck to rot so use topside vents to relieve pressure

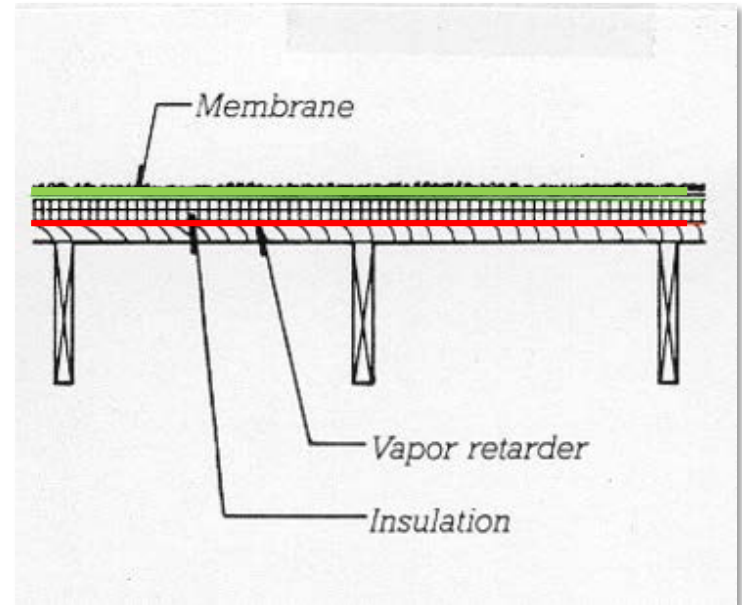

Insulation BETWEEN Membrane and Deck:

Extruded polystyrene insulation is used on roofs (often blue in colour) as it is not penetrable by water so cannot deteriorate due to water logging. It is sensitive to UV radiation so must be protected.

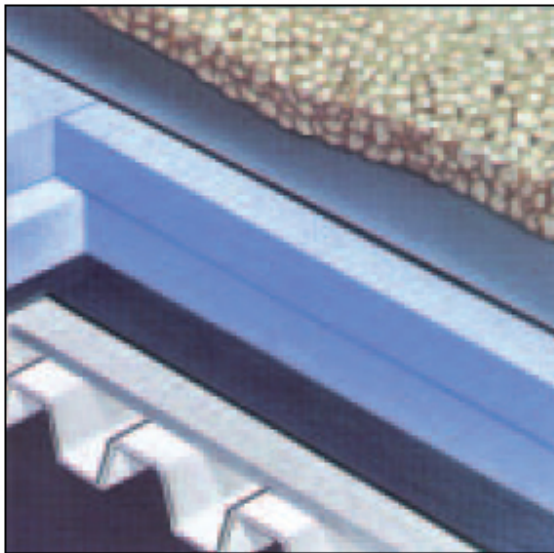

Loose Laid Ballasted
Single-Ply Membrane

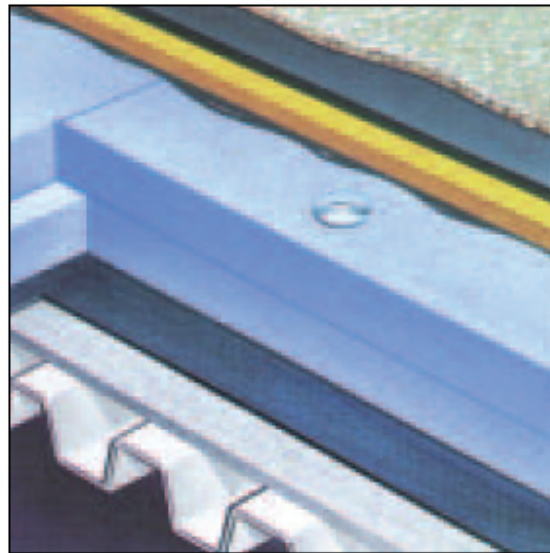

Fully Adhered
Single-Ply Membrane

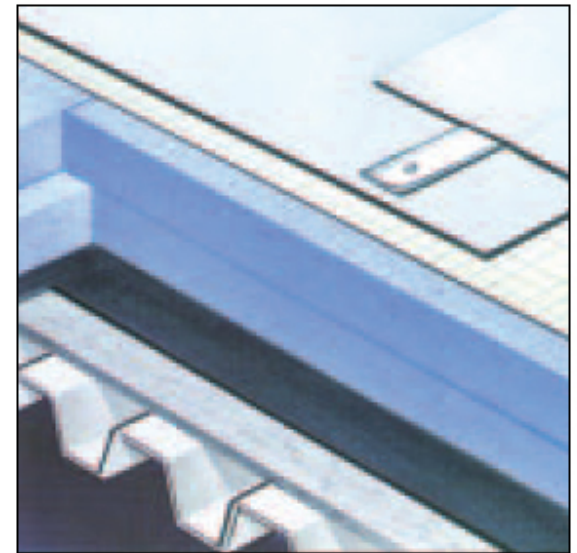

Mechanically Fastened
Single-Ply Membrane

Insulation ABOVE the Membrane:

New concept (post 1970) offering major advantages:

- membrane protected from extremes of heat and cold, is on the warm side of the insulation
- membrane protected from UV radiation
- membrane protected from puncture
- insulation must be extruded polystyrene foam board which is water resistant and covered with a filter layer to prevent migration of ballast

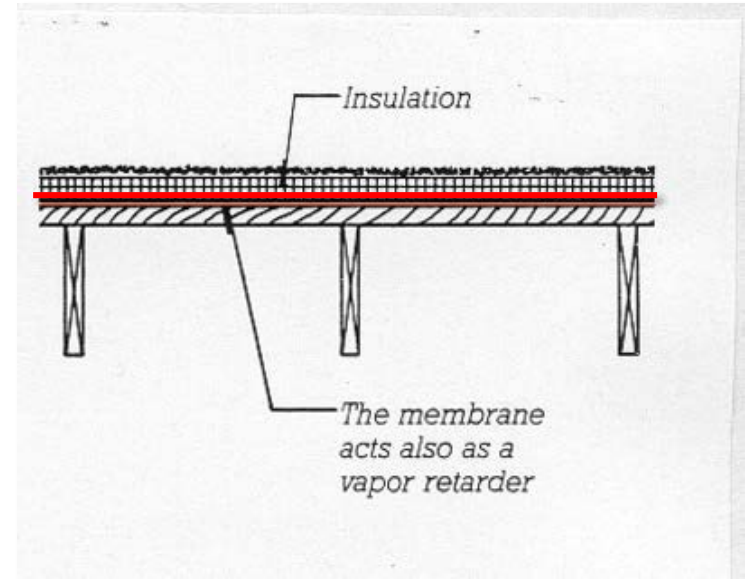

Vapour Retarders for Low Slope Roofs:

- membrane in a protected membrane roof is also the vapour/air barrier
- other types of low slope roofs use two layers of asphalt saturated roofing felt bonded together and to the roof with hot asphalt
- polyethylene film not used as it melts
- situated on the warm side of the insulation

ROOFING MEMBRANES:

THREE PRIMARY TYPES:

- conventional (bituminous built up roofing or BUR)
- prefabricated sheets (single ply)
- cast in situ



Very likely most of these flat roofs use traditional roofing methods.



Conventional: The Built Up Roof (BUR)

- constructed of 3 to 5 layers of bitumen impregnated felts, layered on the roof deck with heated asphalt
- may be located either over or under the rigid insulation
- top layer of gravel ballast to protect asphaltic materials or insulation from UV rays, and to weight roofing materials against wind uplift forces

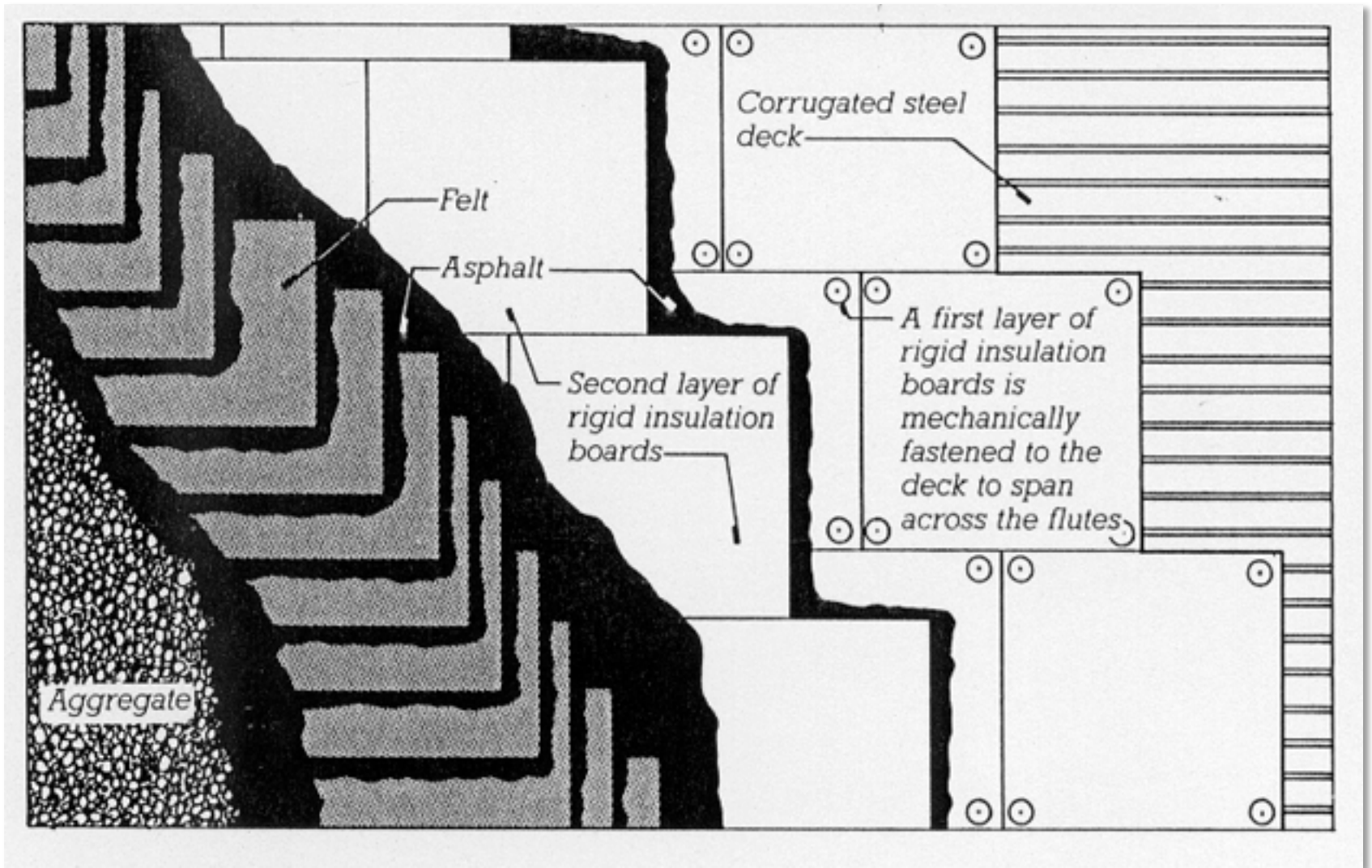

BUR on steel decking: insulation below the membrane

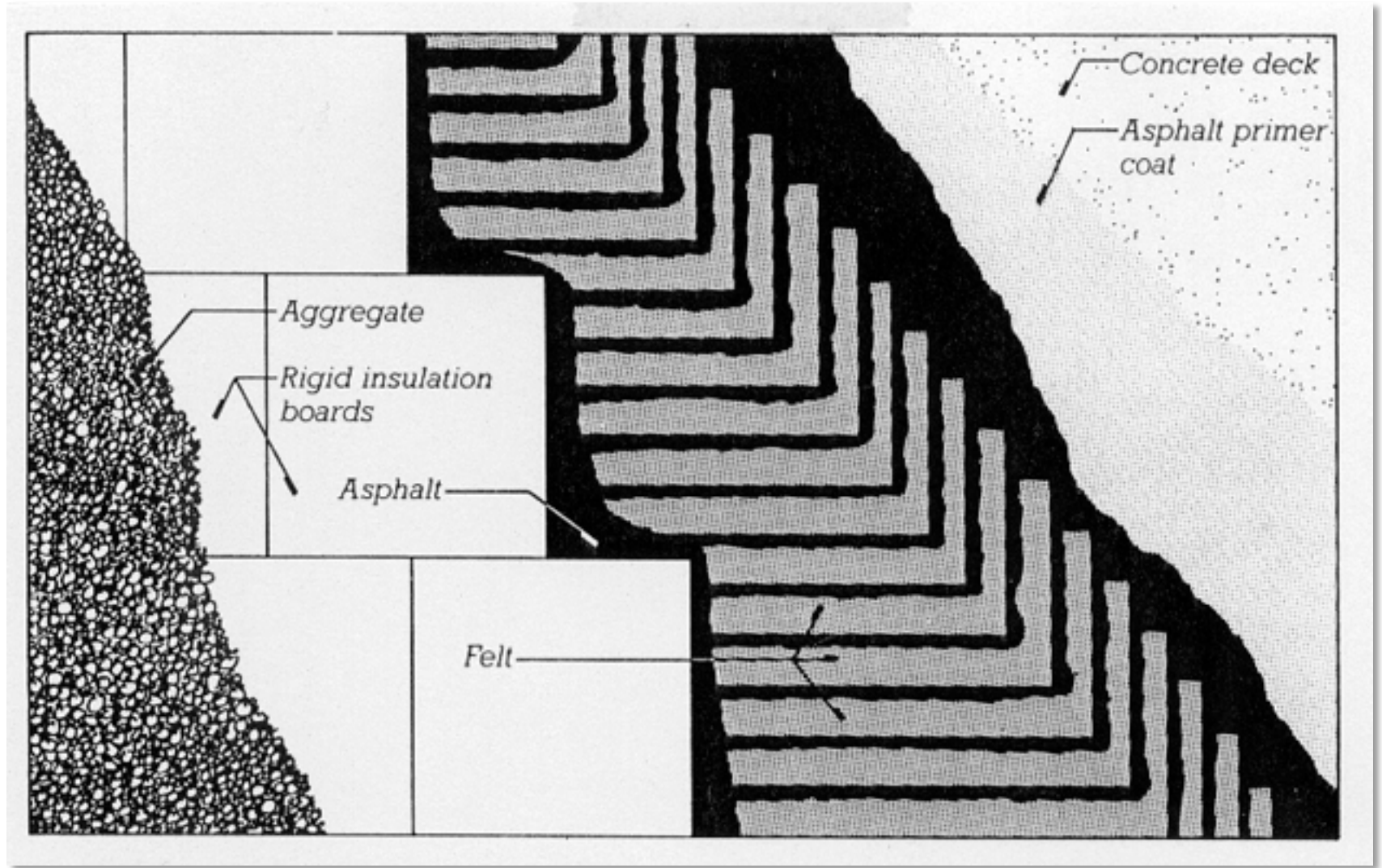

BUR on concrete roof deck: insulation above the membrane

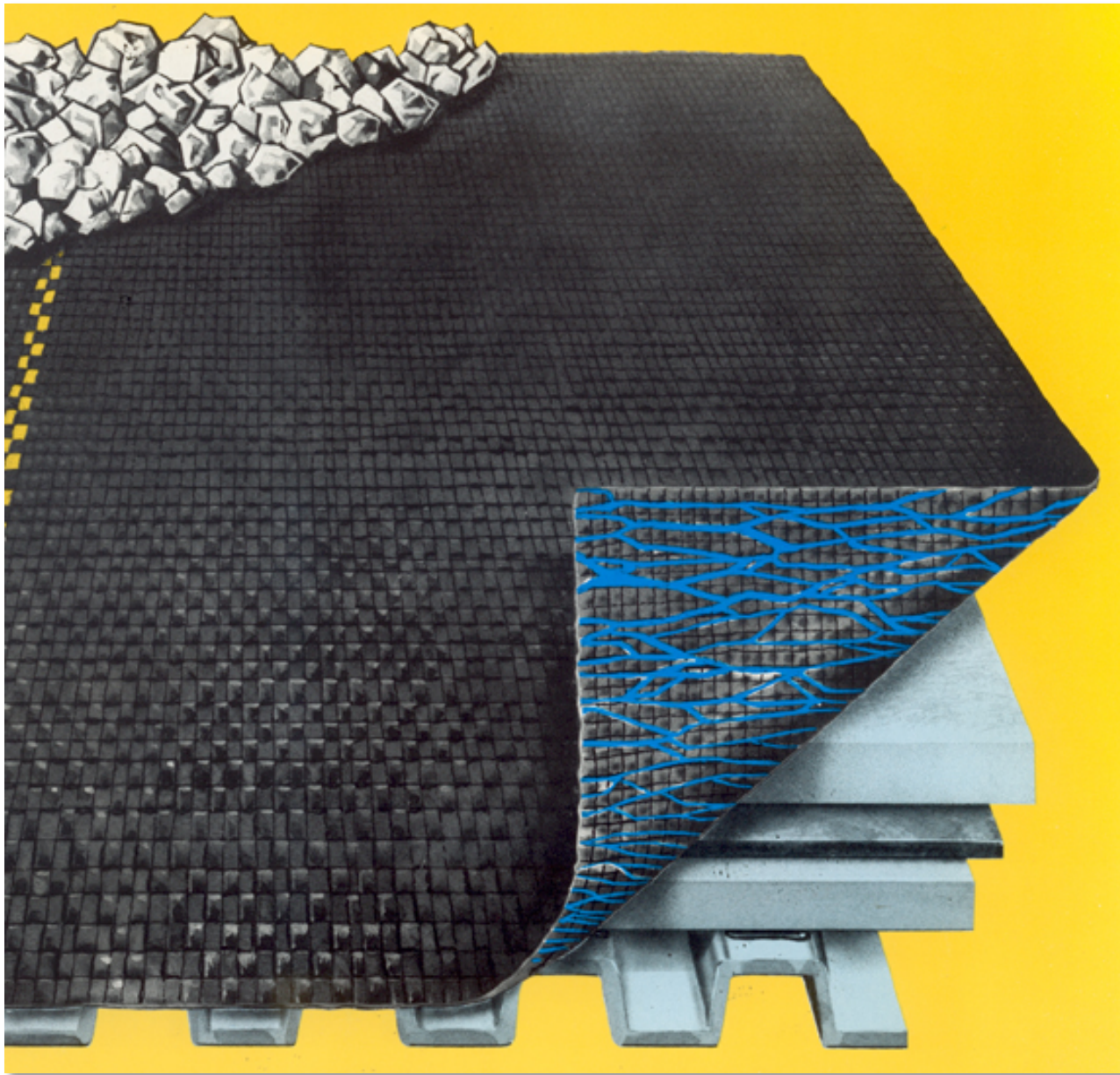

Flat Roof: fibre matt used to keep ballast away from insulation

Built up Roof (BUR)





Built up Roof (BUR)



BUR being
installed
over rigid
polystyrene
insulation
(right)



Prefabricated Sheets: Single Ply

THERMOPLASTIC SHEETS:

- PVC and blends
- EP (ethylene interpolymer)
- CPA (copolymer alloys)

ELASTOMERIC (SYNTHETIC) RUBBER SHEETS:

- vulcanized, EPDM or neoprene
- non vulcanized

MODIFIED bituminous SHEETS:

- polymer modifiers

PREFABRICATED SHEETS: Installation and Attachment

- require less on site labour
- less prone to cracking
- affixed to roof by:
 - adhesives
 - the weight of ballast
 - fasteners concealed in seams between the sheets
 - with ingenious mechanical fasteners that do not penetrate the membrane (if it is flexible enough...)

THERMOPLASTIC SHEETS:

PVC:

- commonly known as vinyl
- seams are sealed either by solvent welding or hot air welding
- may be laid loose, mechanically attached, adhered or used as a protected membrane

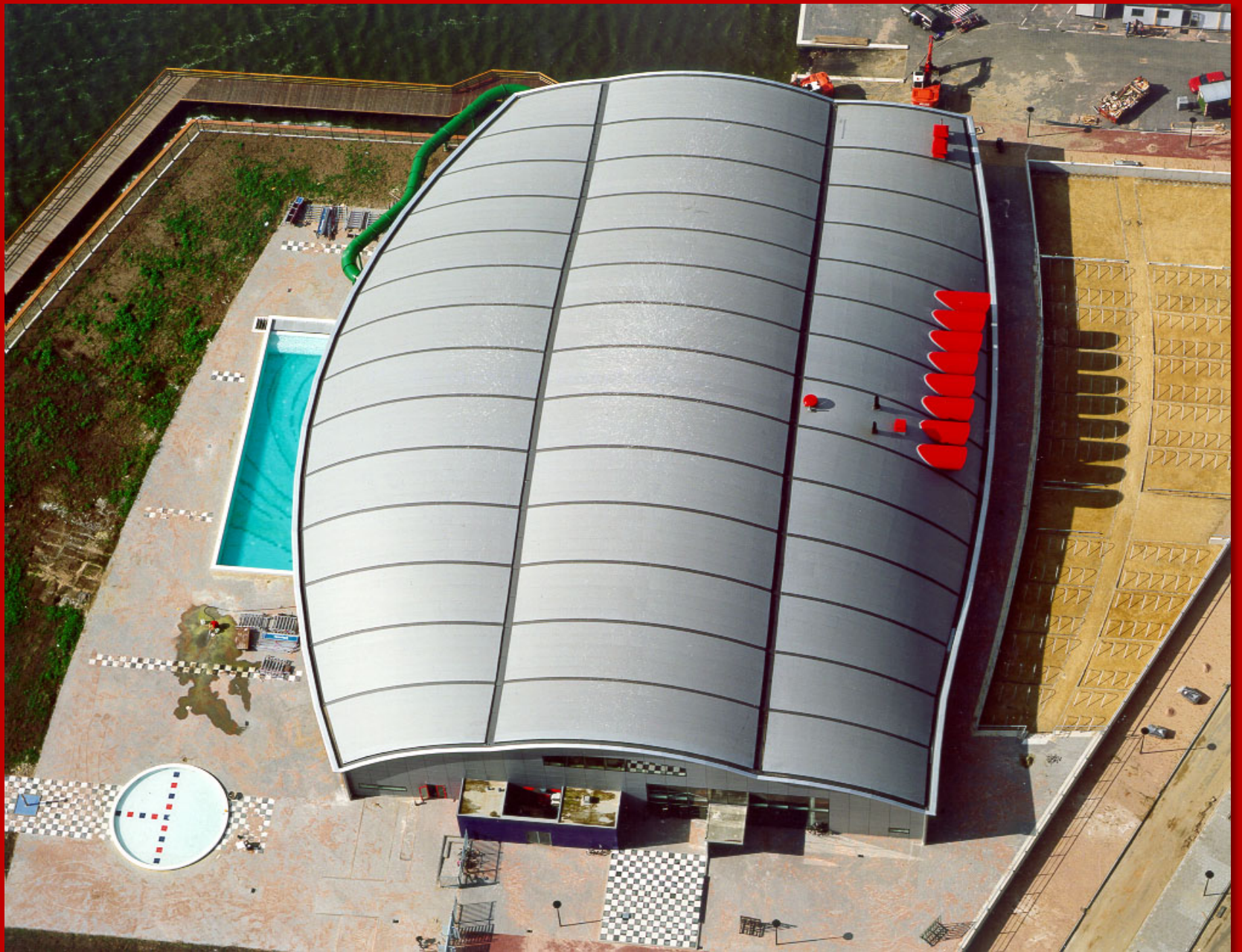



PVC Roof at Pearson International Airport

ELASTOMERIC (SYNTHETIC) RUBBER SHEETS: Neoprene

- high performance synthetic rubber compound
- applied in sheets and joined with an adhesive
- vulnerable to UV rays so coated with a protective layer
- may be adhered, mechanically fastened or laid loose and ballasted
- can be used in a protected membrane roof

ELASTOMERIC (SYNTHETIC) RUBBER SHEETS: EPDM (ethylene propylene diene monomer):

- the most widely used material for single ply roofs
- low in cost
- synthetic rubber made in large sheets
- joined with adhesive, laid loose, adhered, mechanically fastened or used in a protected membrane roof



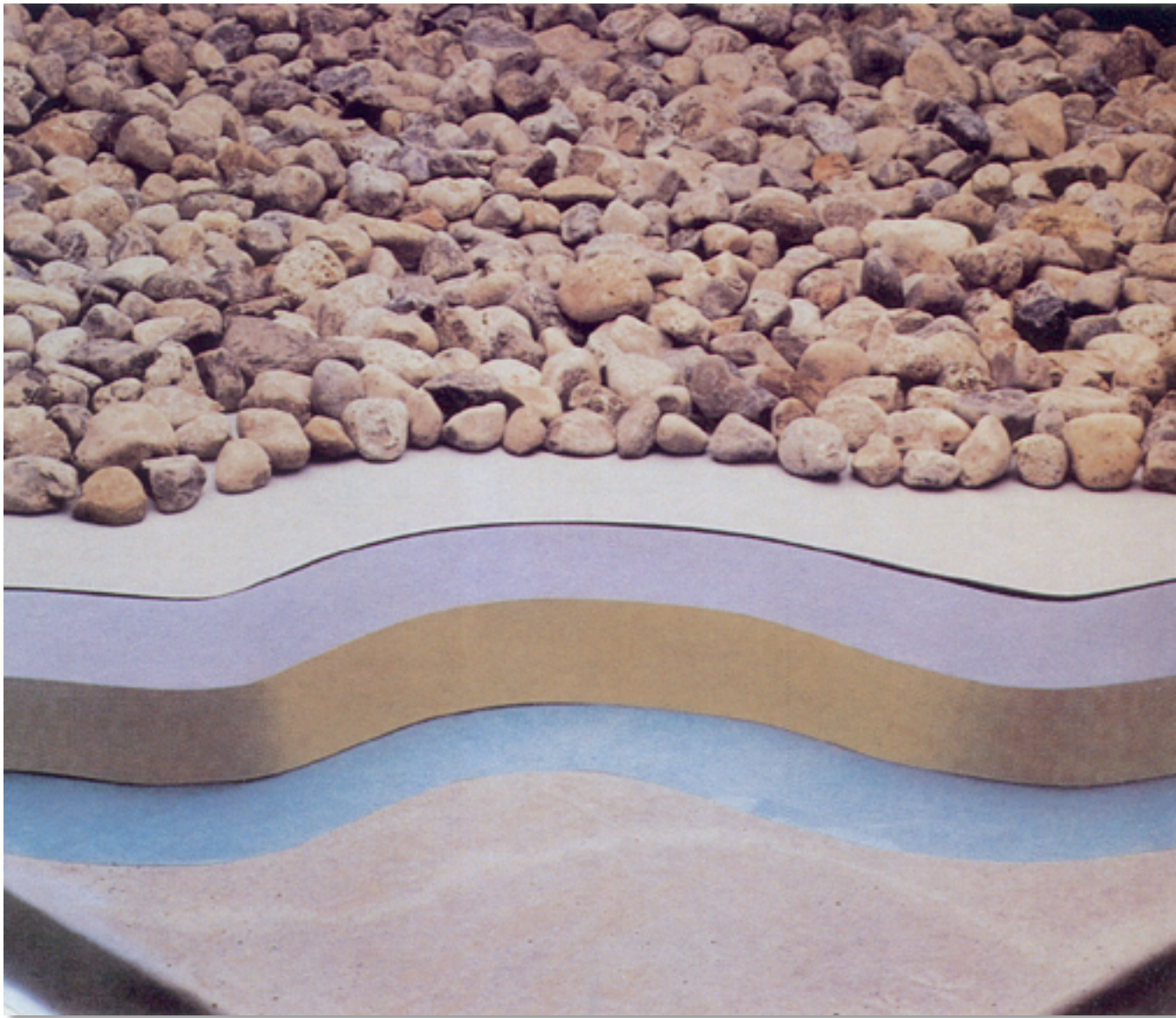

Loose laid, ballasted, membrane

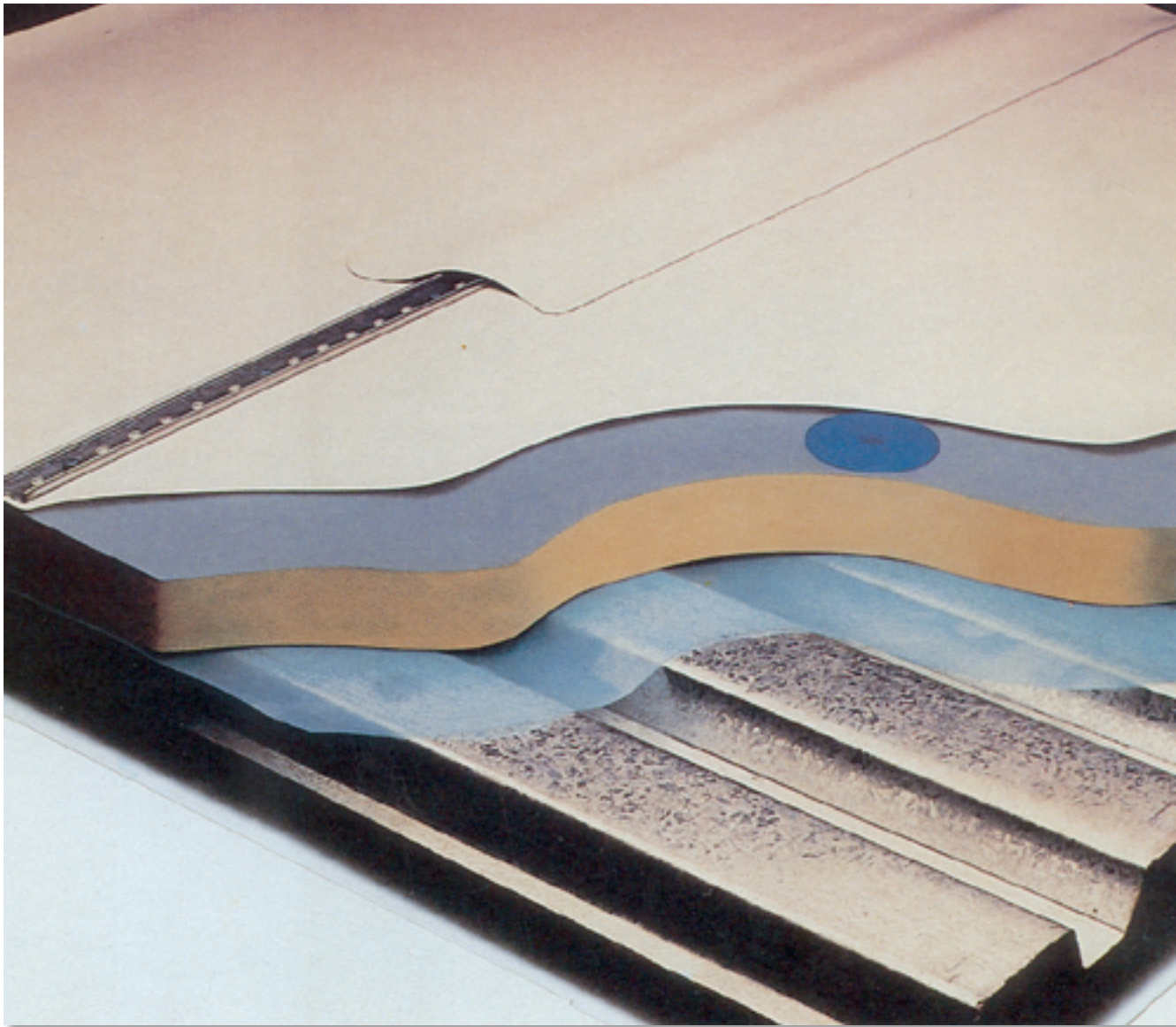

Mechanically fastened membrane: bar type

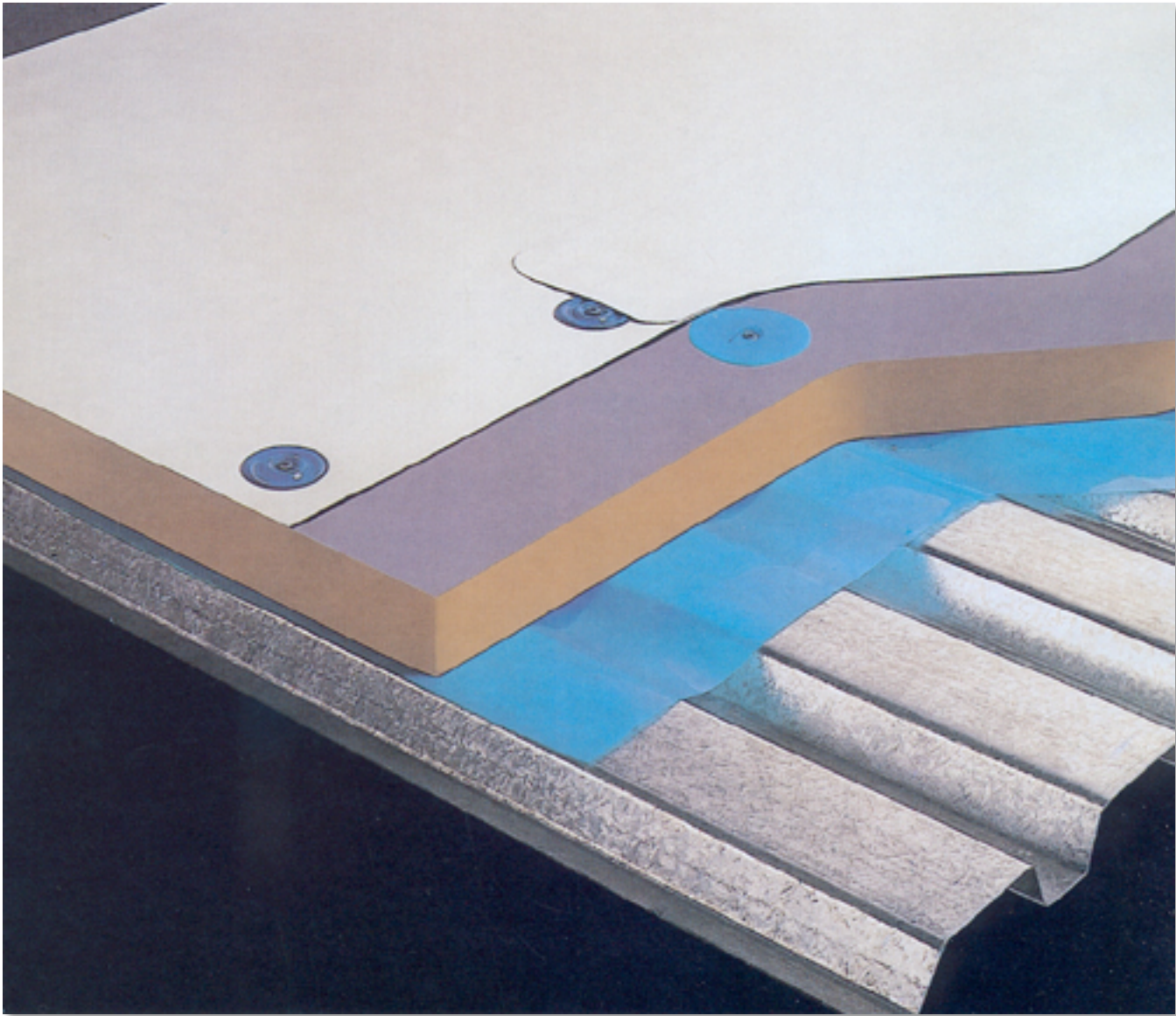

Mechanically fastened with disc fasteners

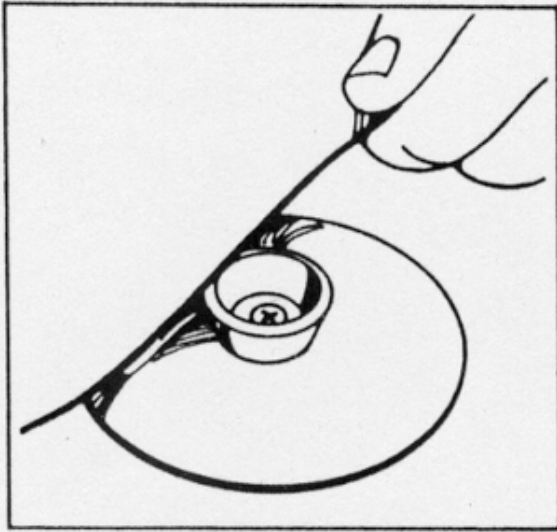

1. Roll membrane over knobbed base plate

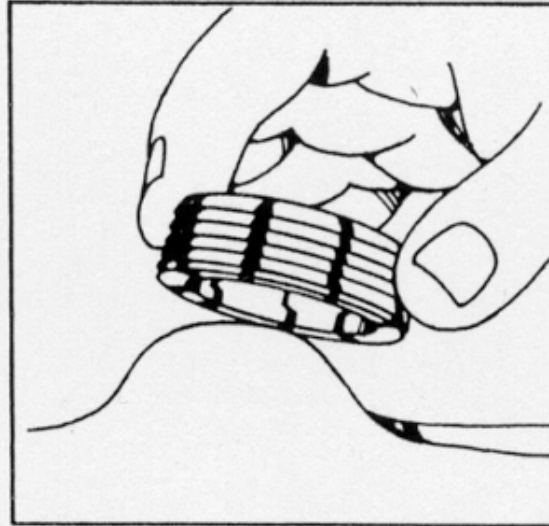

2. Roll and snap on white retainer clip

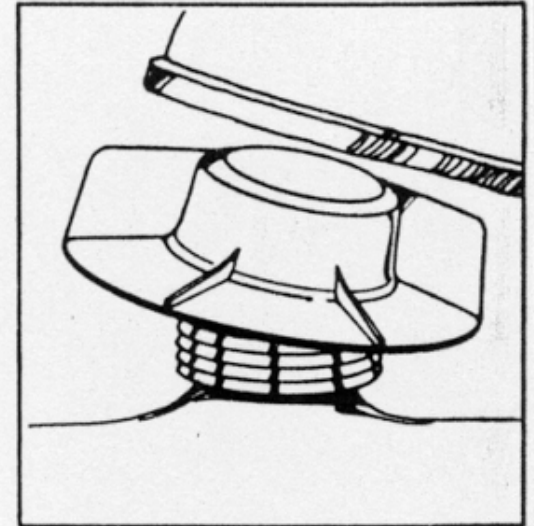

3. Snap and screw on threaded black cap

Disc fastener detail

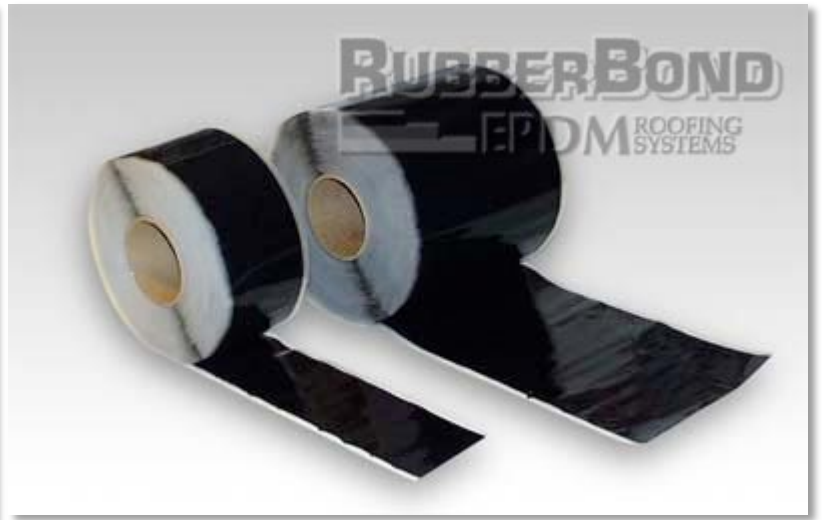
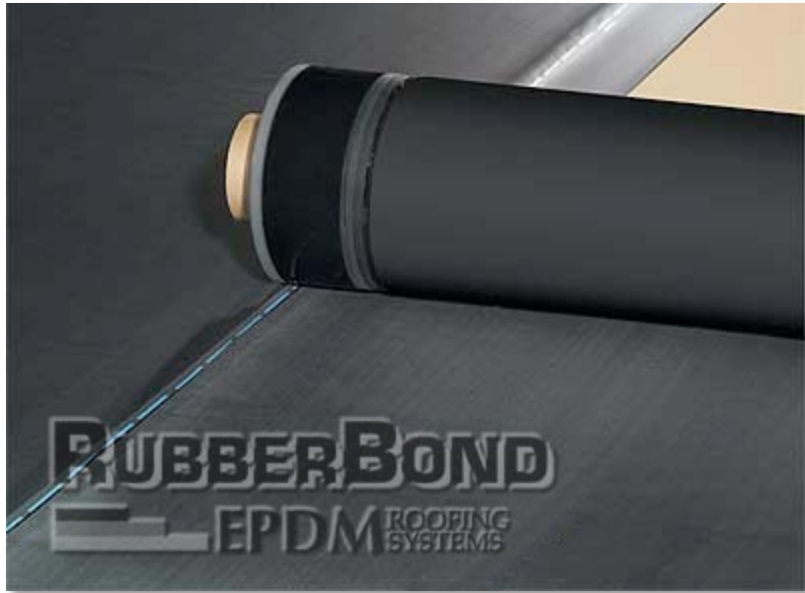

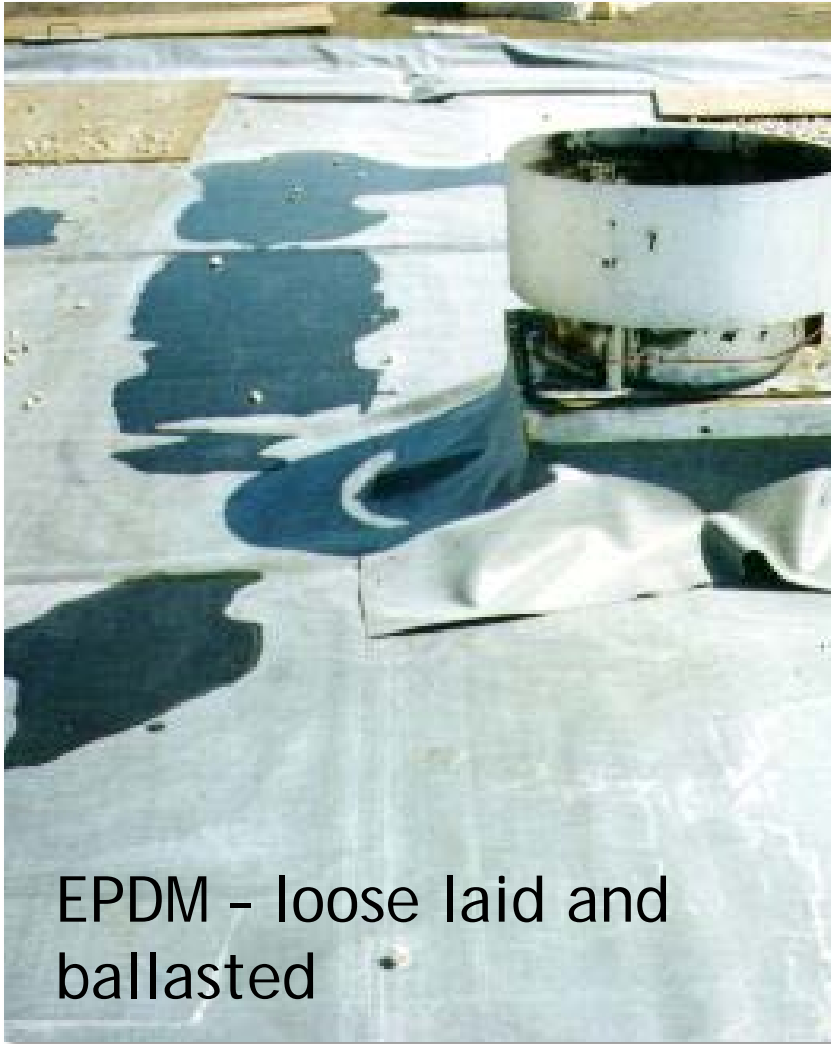

EPDM - loose laid and ballasted



EPDM flashing



Mechanical fastening strips and an EPDM roof



Polymer Modified Bitumens:

- sheets of bituminous material to which polymeric compounds have been added to increase cohesion, toughness and resistance to flow
- reinforced with fibrous mats
- some self adhere, or loose laid or laid in hot asphalt
- seams sealed by torching or hot asphaltic adhesive



Rolls of
polymer
modified
bituminous
roofing
sheets



OCAD modified bitumenous membrane roofing ready for installation





This is the roofing membrane being installed on the top of the new OCAD addition.



This is a multi-ply installation. The black being the base layer and the grey the more durable top layer. The insulation is beneath the black layer.



Detail at parapet. Note water overflow opening.

Can you spot the overflow opening??



There is the
overflow spout!

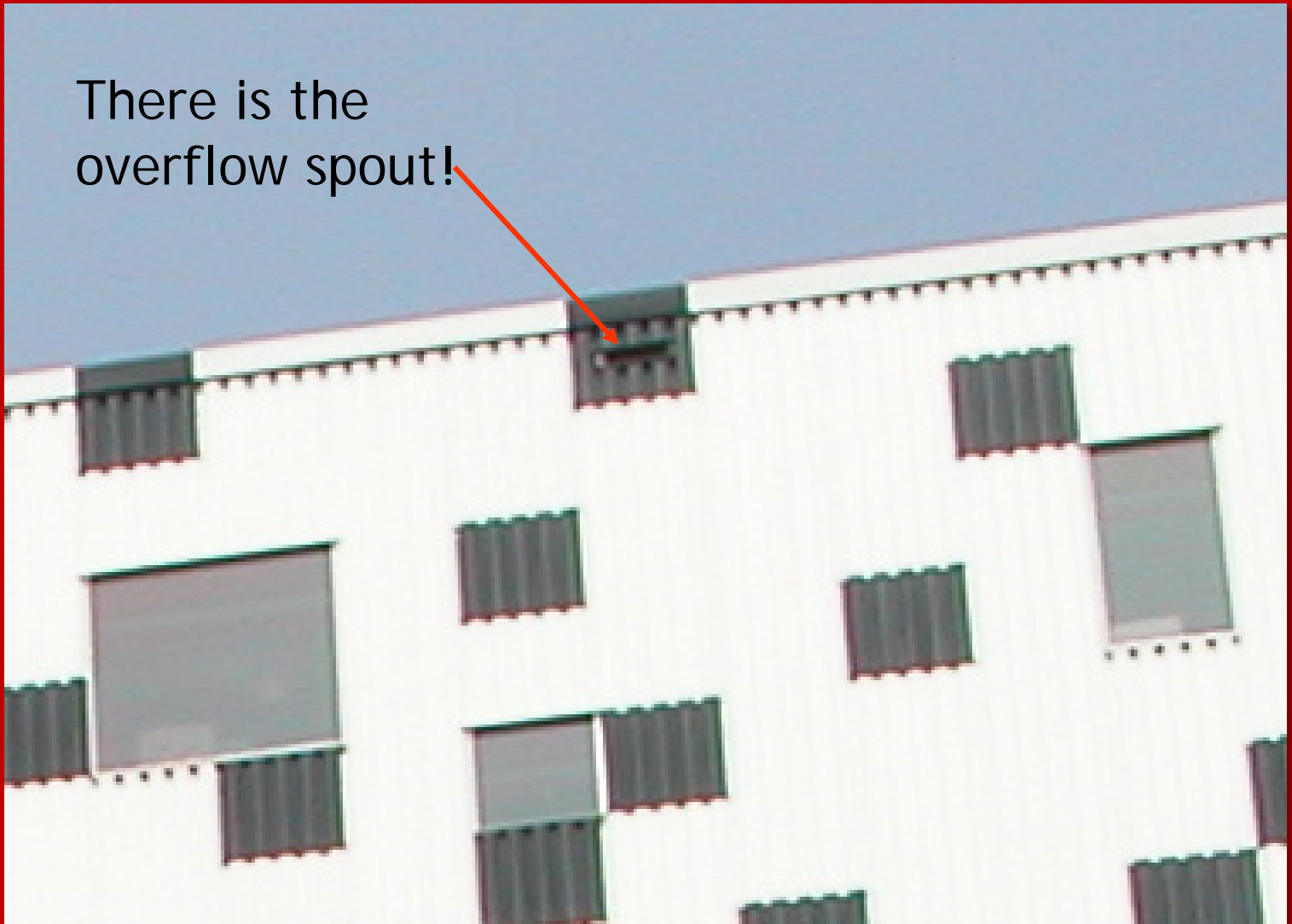



Cast in Situ Membranes:

HOT APPLIED RUBBERIZED ASPHALT

COLD APPLIED LIQUID COMPOUNDS

- various polymeric and bituminous materials

POLYURETHANE FOAM ROOF WITH
PROTECTIVE COATING

Fluid Applied Membranes:

- used primarily for domes, vaults and complex shapes
- applied with a roller or spray gun in several coats and cure to form a rubbery membrane
- used as a spray on waterproofing layer over sprayed on polyurethane foam insulation



Spray applied elastomeric membrane roofing



Spray applied elastomeric membrane roofing

REQUIREMENTS OF ROOFING MEMBRANES:

- tensile strength
- elongation
- crack bridging
- fatigue resistance
- thermal shock
- tear resistance
- abrasion resistance
- lap joint integrity
- static puncture
- impact resistance
- low temp. flexibility
- weatherability
- heat aging
- dimensional stability
- granule embedment

Requirements continued:

- membrane attachment
- flashing attachment
- materials compatibility
- wind uplift resistance

These requirements apply to conditions during manufacture, during installation and in the field in service.

Details

Flexible,
waterproof
expansion joint
cover

Vapor retarder

Compressible
insulation

Wood curb and
cant

Division in
building structure

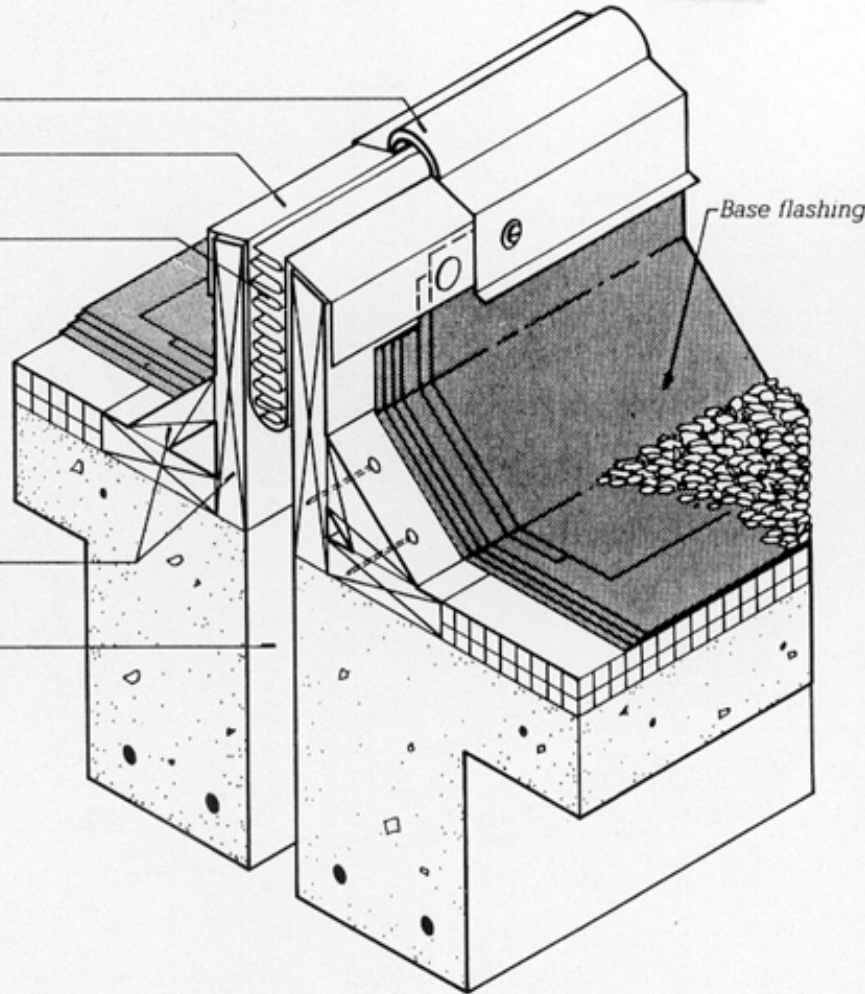

FIGURE 13.27

A building separation joint in a low-slope roof. Large differential movements between the adjoining parts of the structure can be tolerated with this type of joint because of the ability of the flexible joint cover to adjust to movement without tearing. A two-ply base flashing seals the edge of the membrane.

Flat Roof: expansion joint detail

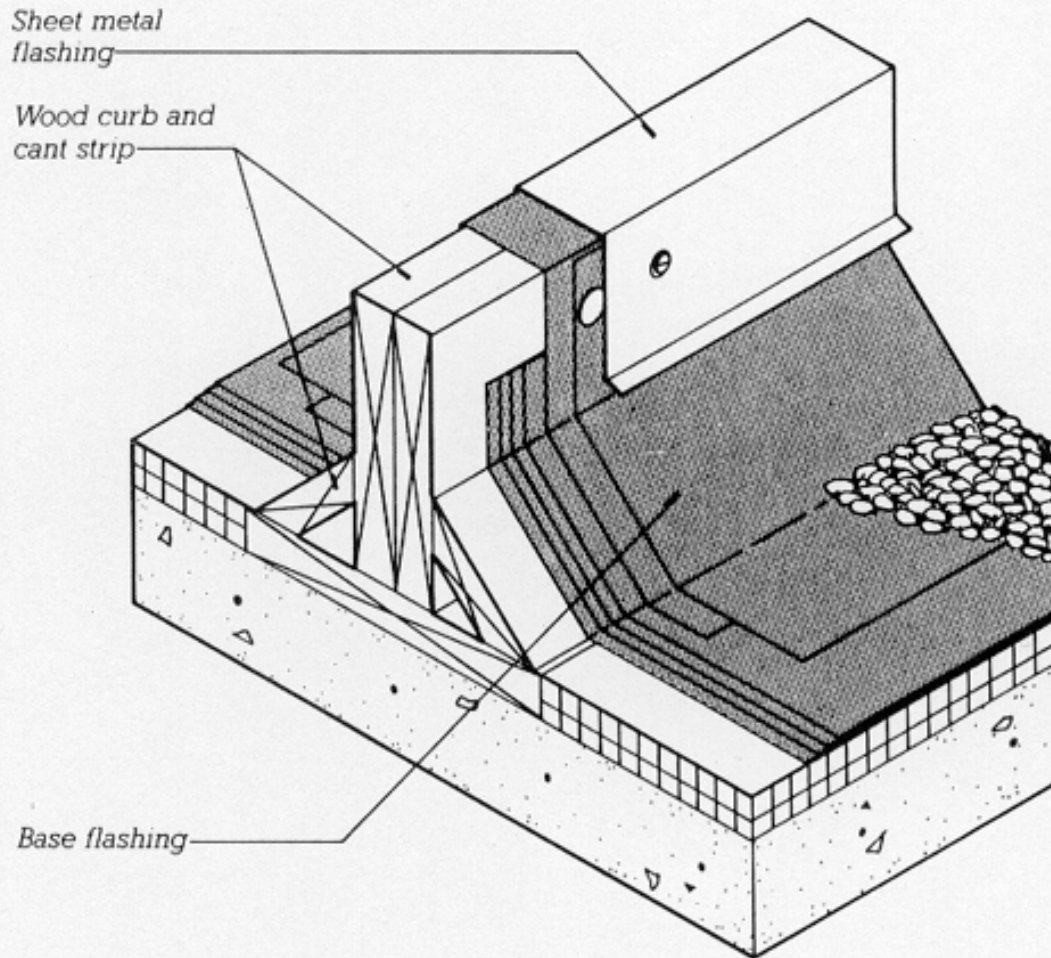

FIGURE 13.28
An area divider is designed only to allow for some movement in the membrane itself, not the entire structure.

Flat Roof: area divider

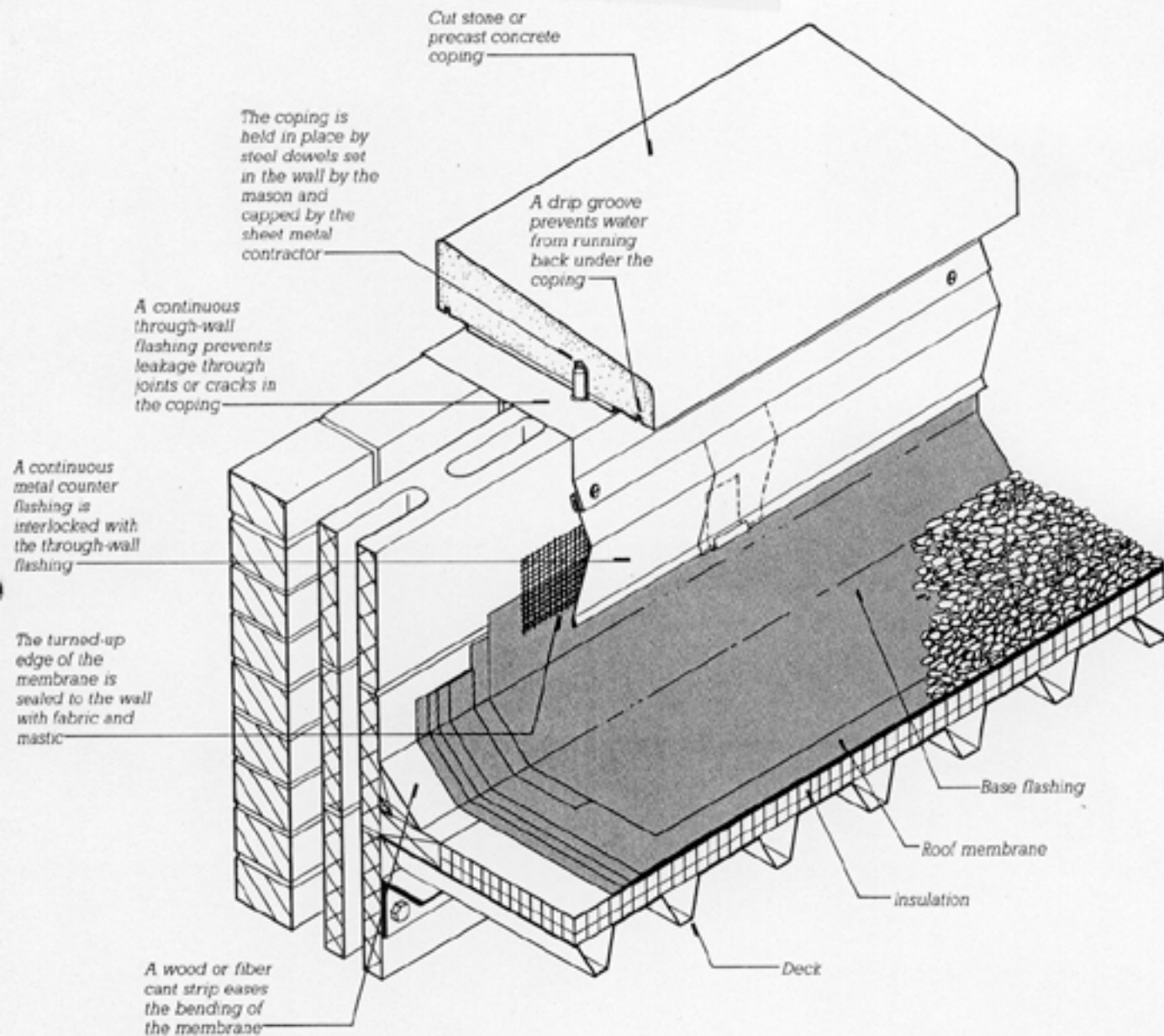

FIGURE 13.29

A conventional parapet design. The coping attachment and flashing are very labor intensive, and therefore costly.

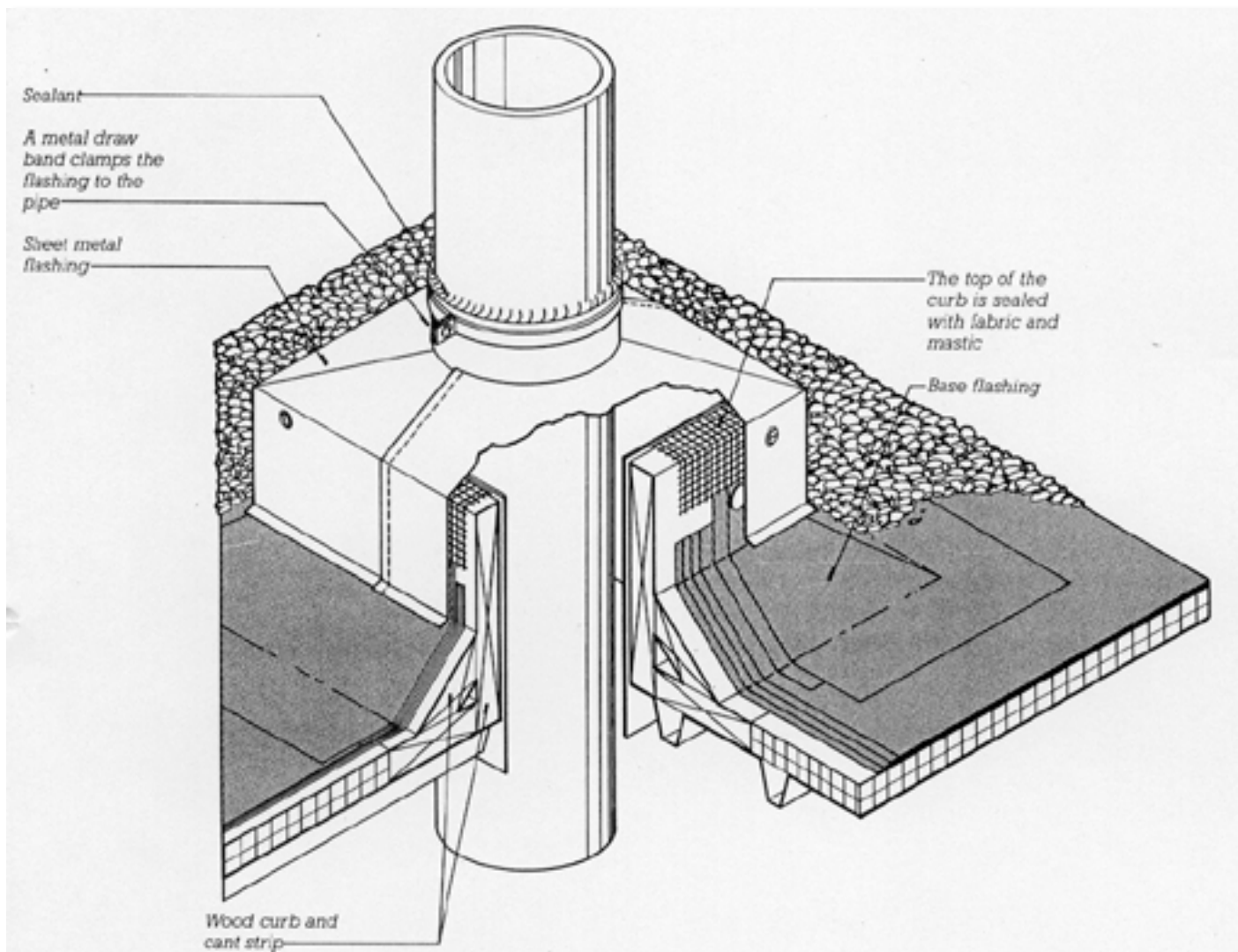
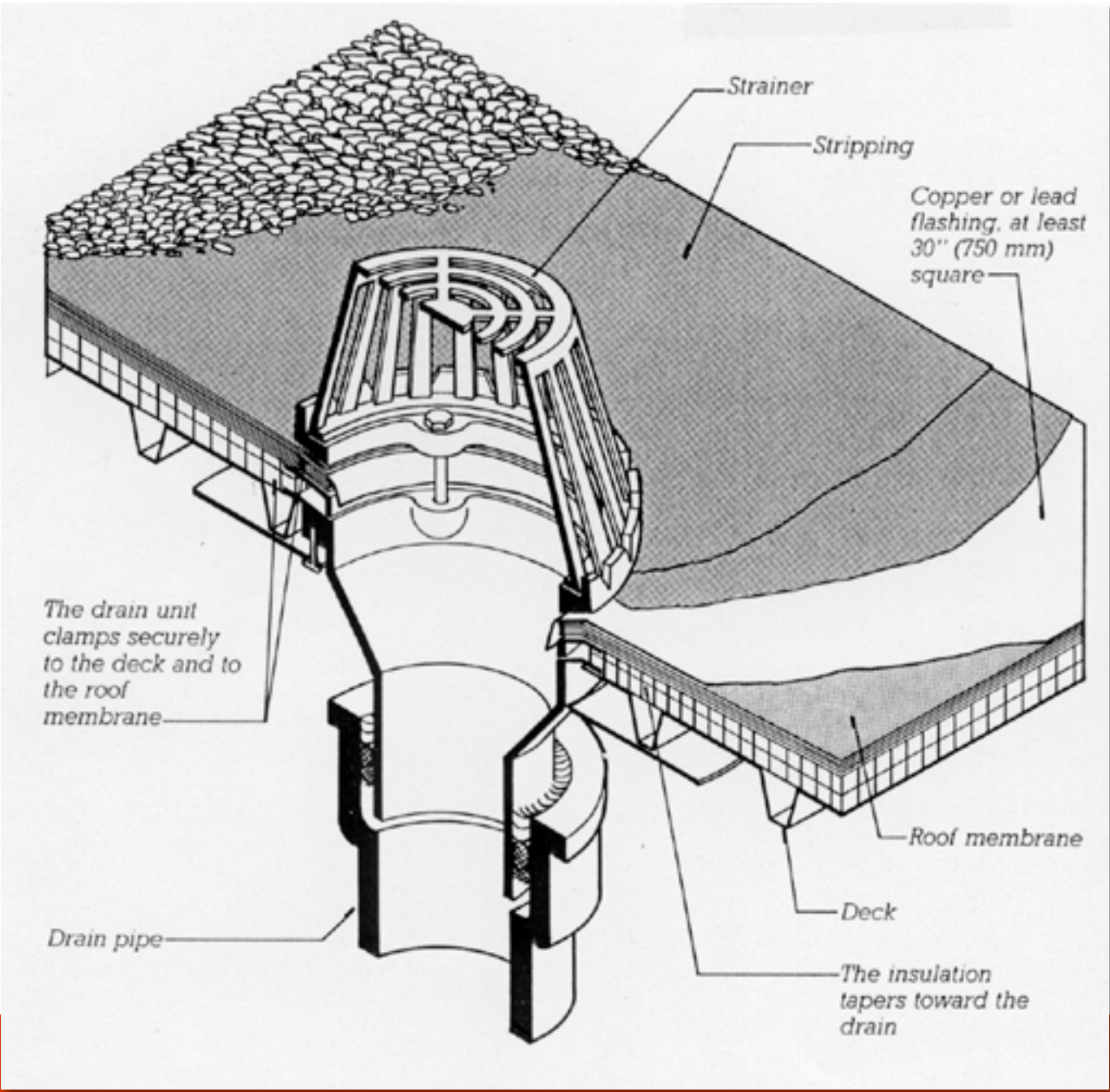

FIGURE 13.33

A roof penetration for a plumbing vent stack. Notice how this and all the previous edge and penetration details for a flat roof use the curb, cant strip, and stripping to keep standing water away from the edge of the membrane.



Strainer

Stripping

Copper or lead
flashing, at least
30" (750 mm)
square

The drain unit
clamps securely
to the deck and to
the roof
membrane

Drain pipe

Roof membrane

Deck

The insulation
tapers toward the
drain

Green Roofs

- A significant environmental improvement to roofing applications has been the “invention” or “adoption” of green roof practices.
- Green roofs are installed over a modified version of more conventional flat roofs, and are normally comprised of a “system” that is sold by several green roof manufacturers (like Soprema)
- These roofs have been used widely in Europe for many years

Two main types:

- **intensive** (thicker growth medium required for larger plants)
- **extensive** (thinner, lighter growth medium required for smaller plants) - *this one is more popular*



Very old green roof over the Halifax Citadel.





Sopranature

NATURE RULES THE ROOF!



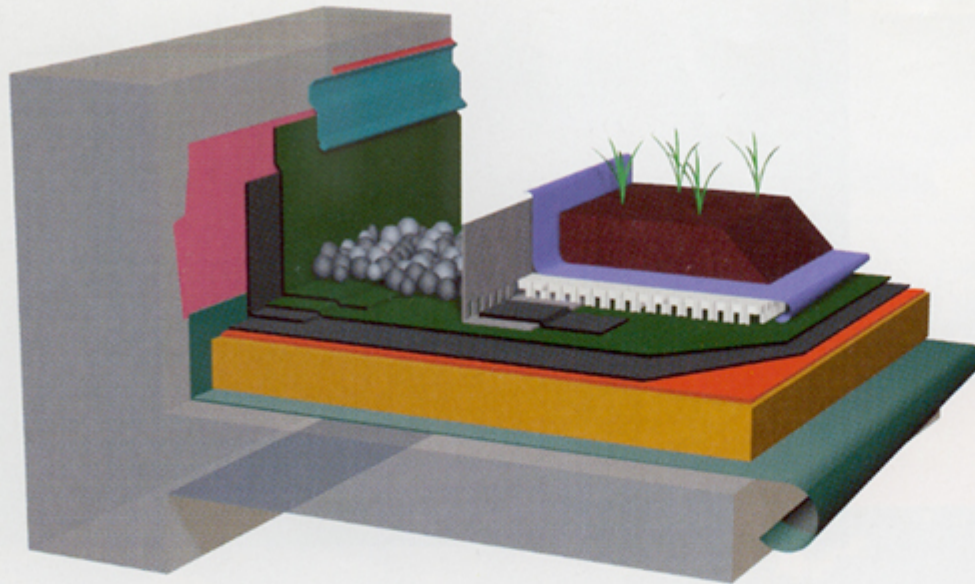

-  Vegetation
-  Sopraflor Growing Medium
-  Soprafiltre
-  Sopradrain PSE or GEO
-  Curb
-  Ballast
-  Sopralene Flam Jardin Cap Sheet
-  Base Sheet Options:
Sopralene Flam 180
or Elastophene Flam
or Self-adhesive Membrane
-  Elastocol 500 Primer
-  Support Panel for Membrane
-  High Density Thermal Insulation
-  Caulking Mastic
-  Vapour Barrier
-  Metal Flashing
-  Support

THE SOPRANATURE SYSTEM

THE SOPRANATURE SYSTEM

SOPRALENE FLAM JARDIN WATERPROOFING MEMBRANE	The 2-ply SOPRALENE FLAM JARDIN system waterproofs the deck. The membrane contains root repelling agents that prevent root penetration.
DRAINAGE LAYER	Its purpose is to facilitate water flow to the roof drains. It is composed of one of the following materials, depending on roof slope: SOPRADRAIN PSE expanded polystyrene (0-5% slope), or SOPRADRAIN GEO drainage geotextile (>5%).
FILTER	SOPRAFILTER is a non-woven synthetic geotextile that prevents fine particles from clogging the drainage layer.
GROWING MEDIUM	SOPRAFLOR growing medium is designed and manufactured to achieve optimum water retention, permeability, density and resistance to erosion in order to support lush vegetation over the entire roof.
VEGETATION	The vegetation is an integral part of the SOPRANATURE system and has been selected for its ability to adapt to extreme weather conditions. In extensive systems, ground covers are used, that is, annuals, biennials and perennials that regenerate themselves and spread naturally over the growing medium. In semi-intensive systems, perennials, shrubs and grass grow in an irrigated rooftop garden.

EDGE PROTECTION

Edges and roof structures must be protected by a 500 mm band of gravel or pavers. A prefabricated border of precast concrete, metal or wood is installed to contain the vegetation areas.

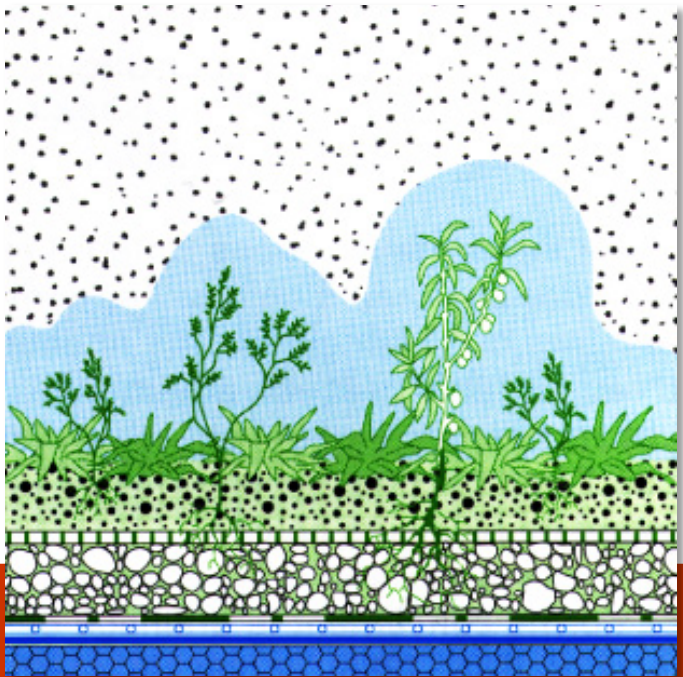

Sopravert is Sarnafil's European green roof system. It maintains that the green roof also helps to buffer from the effects of sound as well as weather, and controls/delays runoff from heavy rain.

Mountain Equipment Coop, Toronto:

- This environmentally conscious retailer has chosen to use green building practices on their buildings.



Vancouver Public Library:

The green roof on VPL is not accessible to the public (has no guard rails at the edge) and is planted with grasses. The idea being to reduce urban heat island while providing a nice view for taller buildings adjacent



YMCA Environmental Learning Centre:

- This building illustrates the ability to install a green roof in a sloped situation





Herb garden green roof on Fairmont Hotel in Vancouver

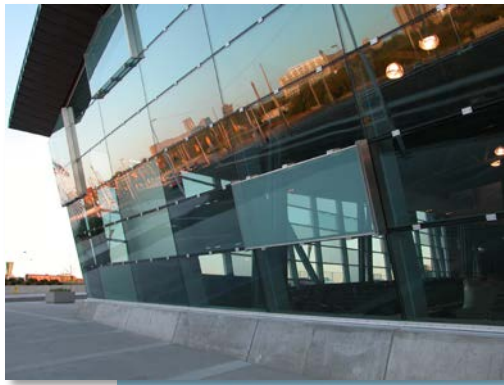

Freshly planted green roof on Canadian War Museum (May 2005)



May 2012



Partial green roof on the Salt Lake City Library by Moshe Safdie



Renzo Piano Science Museum, San Francisco



Operable skylights to vent heat from interior



Drainage paths for excess water



Boston Children's Museum: green roof panels/squares

Green Roof Benefits:

- Planting reduces *urban heat island effects*
- planting can be used to absorb rain water and decrease water that must be processed by the urban storm sewer system
- visually pleasing
- additional insulation
- City of Toronto now has a Green Roof By-law that requires Green Roofs on new commercial buildings.

Green Roof Drawbacks:

- Why not do a green roof?
- Additional first expense
- additional structure required to support roof
- plants must be hardy and not need watering (over the long term)
- watering essential during the first 2 or so years until roots become established
- Does not benefit insulation as materials are damp so conductive rather than insulative