



ROOFING TECHNOLOGY



Why do we need to care about roofs?

- Roof and membrane failures are the most often litigated parts of a building
- good detailing is paramount
- never use materials or systems that have not been “approved” or tested by a reputable agency

GENERAL ROOFING TERMS

FROM THE INTERNATIONAL LIBRARY OF TECHNOLOGY, 33C, 1909

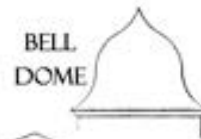

It is important to be familiar with the general roofing terms regarding their general shape and configuration.

ROOFING TYPES:

THE TWO PRIMARY TYPES OF ROOFING WE MUST CONSIDER ARE **FLAT** AND **PITCHED**:

Flat roofs are those slope is **LESS THAN 1 in 4** and use waterproof membranes (also called Low Slope)

Pitched roofs have slopes of **1 in 4 or GREATER** and generally use shingles

Roof Type Selection

- Depends on building use
- Span
- Structural materials
- Need to shed water or snow
- Need to provide overhangs for shading
- Need to provide overhangs to protect the wall materials
- Need for insulation (and type of insulation to be used - batt vs foam/rigid)
- Incorporation of skylights or roof glazing

Common Fact

- Flat roofs are prone to leaking
- Leaks are difficult to find as the entry point for the leaking water is usually not near the point of apparent leakage
- Sloped roofs tend to stay watertight if properly built (pay attention to ice dams...)

Roof Insulation Types

- Insulation varies in its water resistance
- Can be quite permeable to air/vapour **or** act as an air barrier
- Batt types are air permeable
- Closed cell foams are air Impermeable
- SO...
- Batt types must be ventilated
- Closed cell foams need not be ventilated

Environmental Issues

Insulation Material	R-value R/inch	Density lb/ft ³	Emb. E MJ/kg	Emb. Carbon kgCO ₂ /kg	Emb. Carbon kgCO ₂ /ft ² •R	Blowing Agent (GWP)	Bl. Agent kg/kg foam	Blowing Agent GWP/bd-ft	Lifetime GWP/ft ² •R
Cellulose (dense-pack)	3.7	3.0	2.1	0.106	0.0033	None	0	N/A	0.0033
Fiberglass batt	3.3	1.0	28	1.44	0.0165	None	0	N/A	0.0165
Rigid mineral wool	4.0	4.0	17	1.2	0.0455	None	0	N/A	0.0455
Polyisocyanurate	6.0	1.5	72	3.0	0.0284	Pentane (GWP=7)	0.05	0.02	0.0317
Spray polyurethane foam (SPF) – closed-cell (HFC-blown)	6.0	2.0	72	3.0	0.0379	HFC-245fa (GWP=1,030)	0.11	8.68	1.48
SPF – closed-cell (water-blown)	5.0	2.0	72	3.0	0.0455	Water (CO ₂) (GWP=1)	0	0	0.0455
SPF – open-cell (water-blown)	3.7	0.5	72	3.0	0.0154	Water (CO ₂) (GWP=1)	0	0	0.0154
Expanded polystyrene (EPS)	3.9	1.0	89	2.5	0.0307	Pentane (GWP=7)	0.06	0.02	0.036
Extruded polystyrene (XPS)	5.0	2.0	89	2.5	0.0379	HFC-134a ¹ (GWP=1,430)	0.08	8.67	1.77

1. XPS manufacturers have not divulged their post-HCFC blowing agent, and MSDS data have not been updated. The blowing agent is assumed here to be HFC-134a.

R-Value Comparison

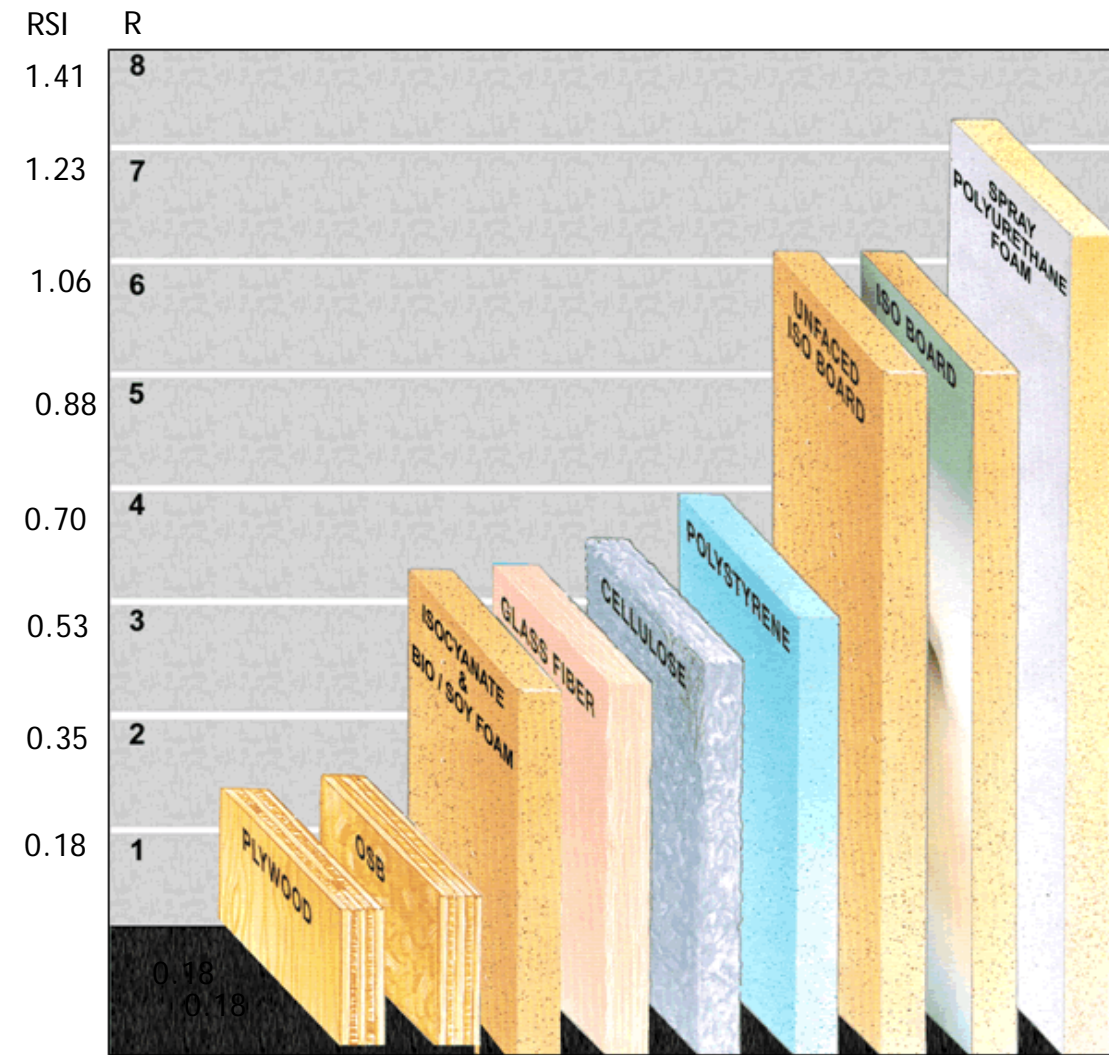

R/RSI value per inch/25mm of various insulating materials

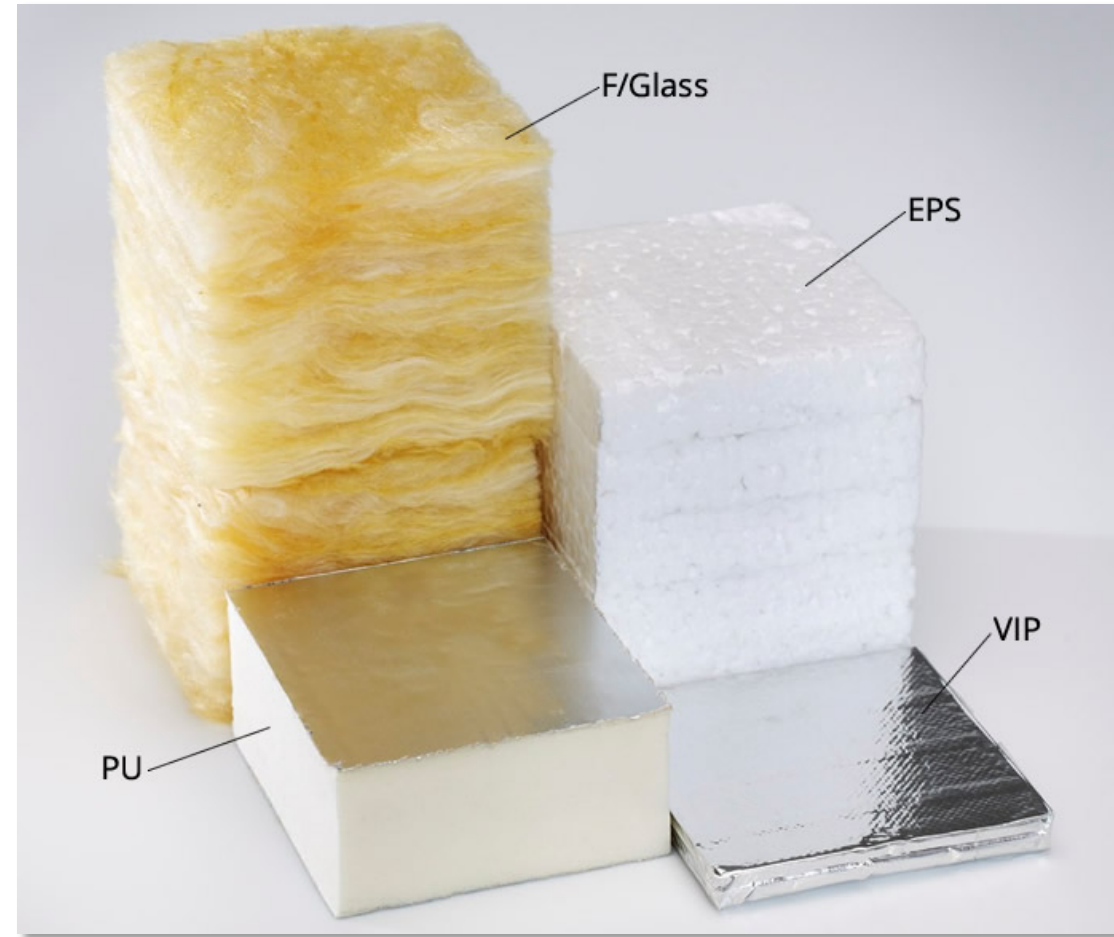

How Much Insulation?

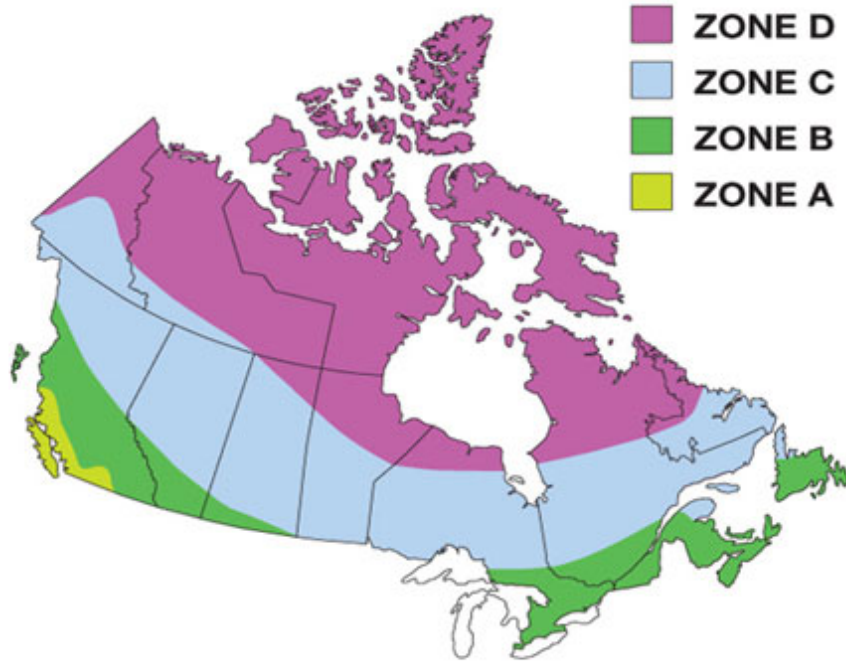

ZONE D	Over 6500 HDD	R51 = 13" XPS	or 16" F batt
ZONE C	5000 to 6500 HDD	R38 = 9.5" XPS	or 12" F batt
ZONE B	3500 to 5000 HDD	R32 = 8" XPS	or 10" F batt
ZONE A	Up to 3500 HDD	R26 = 6.5" XPS	or 8" F batt

ZONE		A	B	C	D
Walls	RSI	3.0	3.6	4.1	5.3
	R	17.0	20.0	23.0	30.0
Basement walls	RSI	3.0	3.0	3.0	3.0
	R	17.0	17.0	17.0	17.0
Roof or ceiling	RSI	4.5	5.6	6.7	9.0
	R	26.0	32.0	38.0	51.0
Floor (over unheated spaces)	RSI	4.7	4.7	6.7	9.0
	R	27.0	27.0	38.0	51.0

Courtesy Producer Member Thermo-Cell

More insulation is required in ceilings as hot air rises so there is more thermal loss in that direction.

<https://isolofoam.com/en/r-rsi-converter/>

Divide number by 25 to convert to RSI/mm

Batt Type Insulation

- Typical for Pitched Residential applications
- Most often laid on the ceiling of the attic leaving lots of ventilation space above





Can be installed in roll form or blown in loose (loose often for retrofit as easier)



Cellulose

Considered to be the most environmentally benign.



Some batt insulation comes with a backer paper to use for installation – the paper instead of a plastic vapour barrier.

Note the wood strapping that is being used to create the vent space between the insulation and the decking







When dense mineral wool is placed on a flat roof it must be in a protected position so that it doesn't get wet.



Roofing membrane is being installed over the dense/rigid rockwool insulation to protect it from moisture.

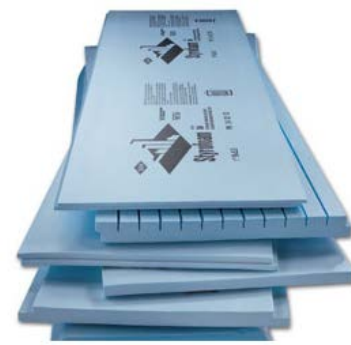

Polystyrene: Expanded (EPS) vs. Extruded (XPS)

- XPS (Extruded polystyrene) refers to the coloured solid foam panels you most often see on the outside of buildings under construction. It offers a higher density and higher R-value per inch than EPS (expanded polystyrene) but because of its lower cost, EPS offers more R-value per dollar spent.
- Manufacturers of XPS and EPS claim both products can be recycled, but a complete life cycle analysis shows EPS having a better overall environmental impact when compared to XPS, as EPS can be recycled in many more ways at the end of its usefulness.

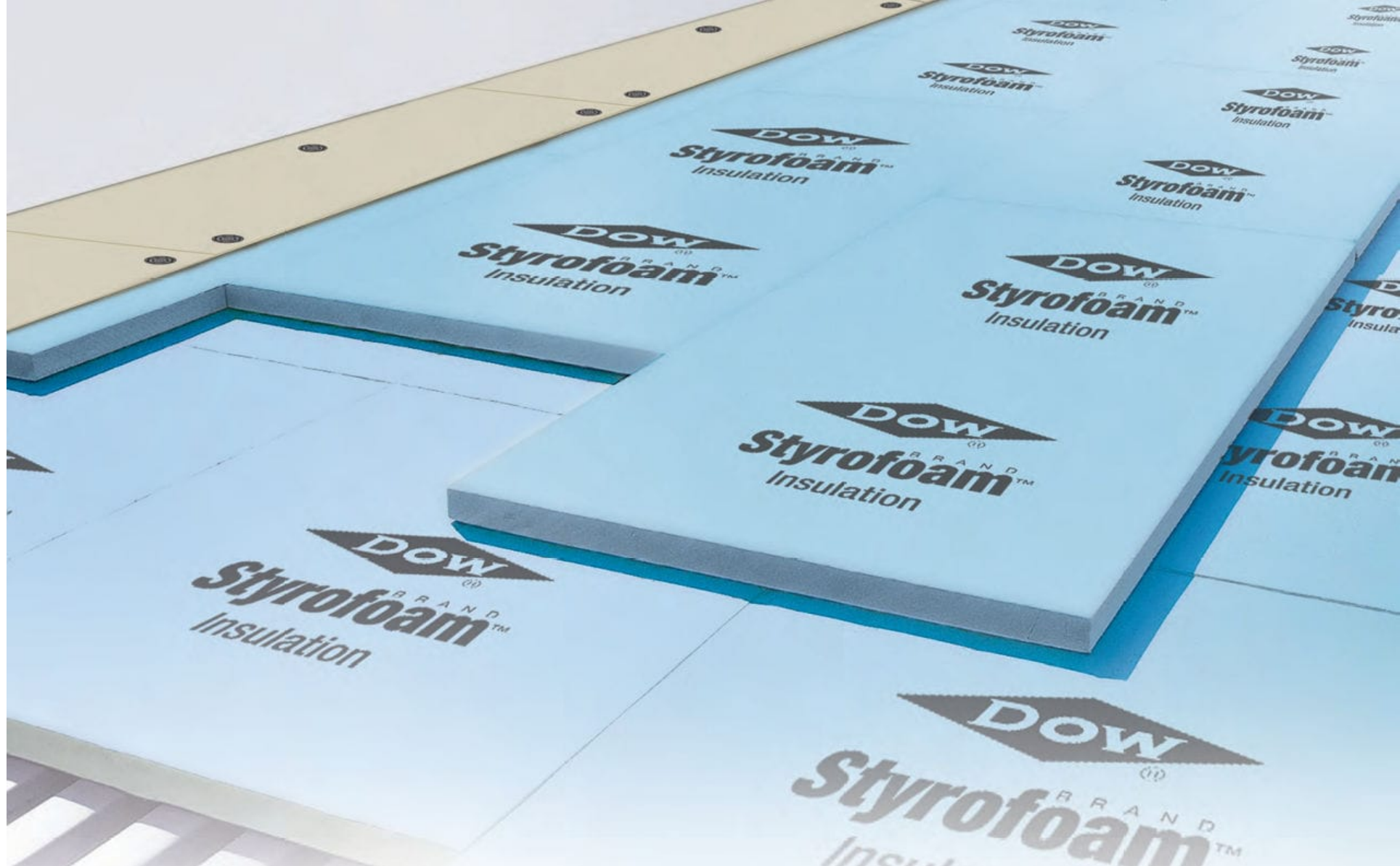

XPS, though waterproof, is placed below the membrane here to protect it from UV radiation.



When XPS is placed above the membrane it must be ballasted to protect it from wind uplift.

Here you see a drainage board covered by a filter cloth to keep the ballast from creeping down to damage the roofing membrane.

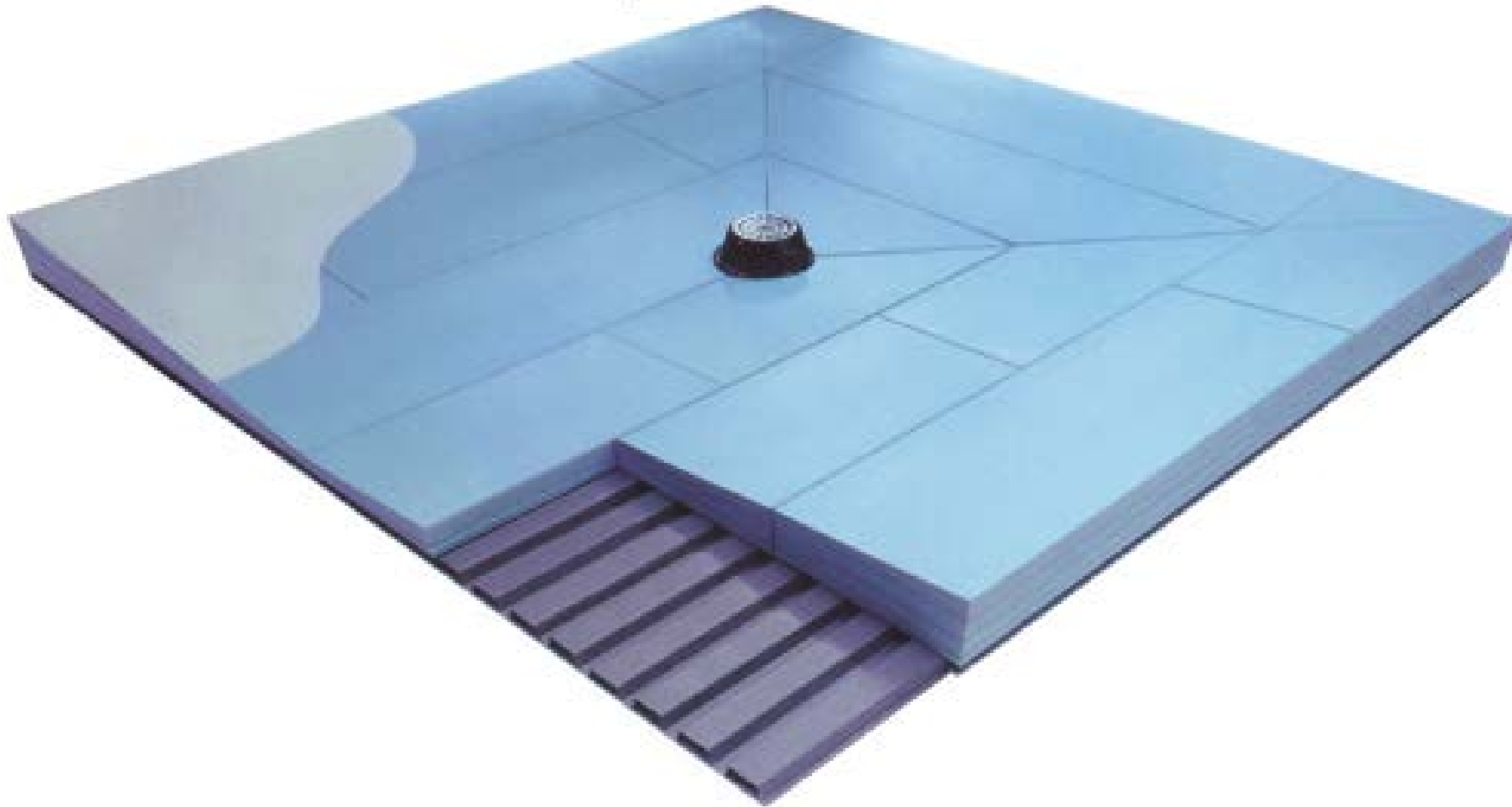

XPS insulation comes in tapered boards for use on roofs to support drainage where a sloped structural deck is not desired.

Expanded Polystyrene Foam (EPS)



EPS comes in varying thicknesses and also in tapered slabs to assist in roof drainage.

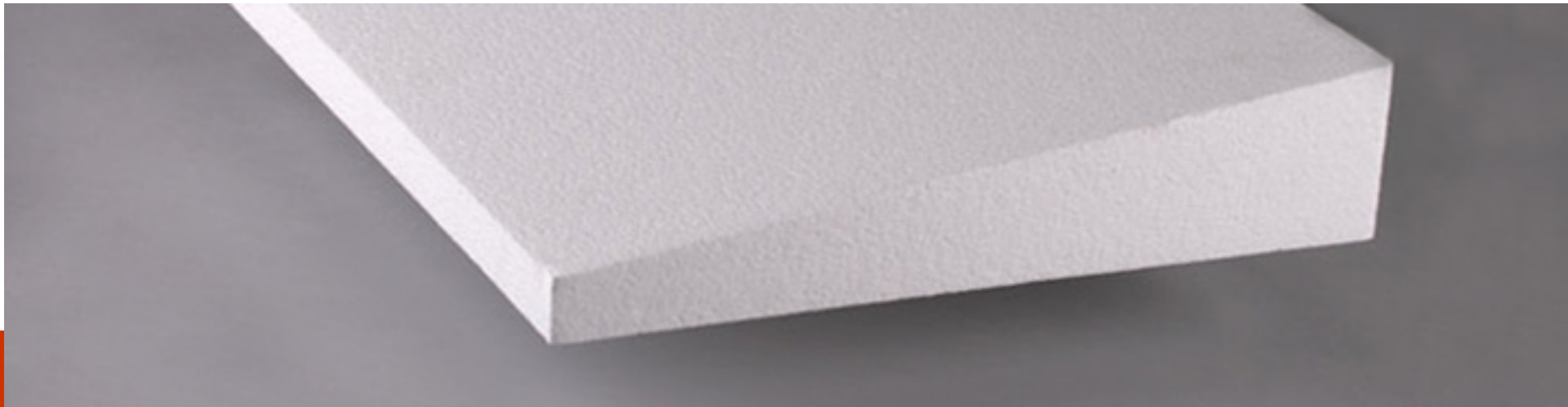



EPS foam used on a roof, installed under the roofing membrane in a protected position.

Tapered slabs are used to create the slope to drain the roof, leaving the roof itself, flat.



Pitched Roof Materials:

SHINGLES:

- asphalt, sawn wood, shakes, slate, clay tiles or concrete tiles

THATCH:

- bundles of leaves, reeds or grasses

ARCHITECTURAL SHEET METAL:

- lead, copper and terne (stainless steel or sheet steel) with flat or standing seams

Terne is an alloy coating that was historically made of lead and tin used to cover steel, in the ratio of 20% tin and 80% lead. Currently, lead has been replaced with the metal zinc and is used in the ratio of 50% tin and 50% zinc.



Traditional roofing types



Traditional
thatched roof





"old" vs. "new" slate



Slate is typically installed over wood slats rather than plywood sheathing.





The life span of an asphalt-shingle roof shingles is somewhere between 15 and 30 years, depending on the quality of the roofing shingles and the climate in your region. Wind can often cause as much damage as water, cold temperatures and sun.

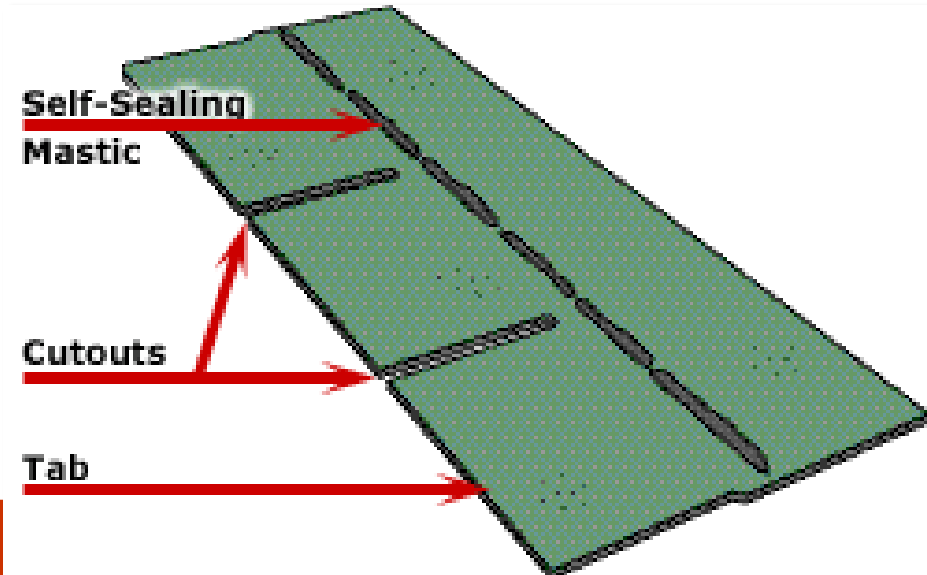

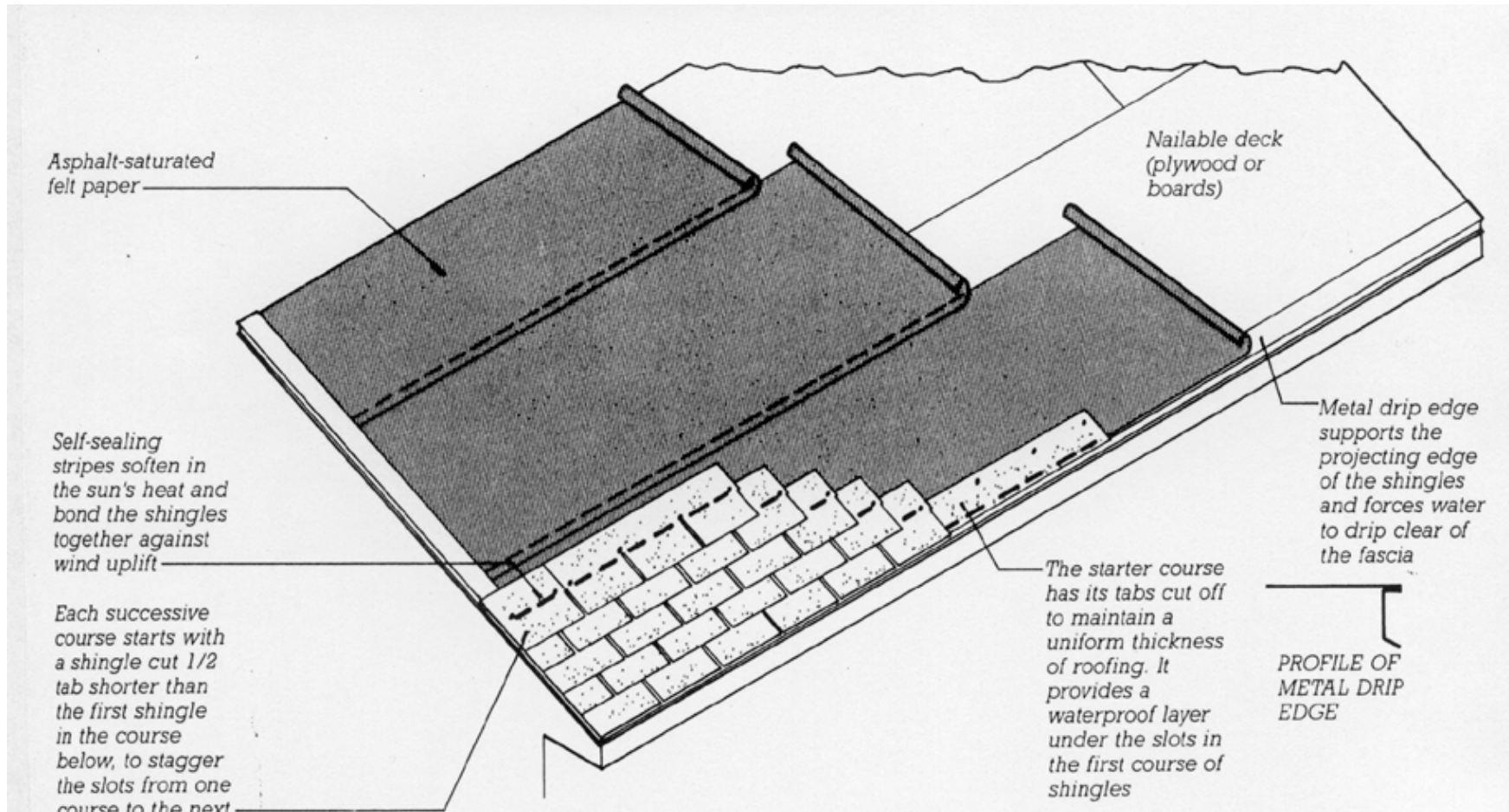

FIGURE 13.42
Starting an asphalt shingle roof. Most building codes require the installation of a snow-melt barrier beneath the shingles at the eave in regions with cold winters. The most effective form of barrier is a 3-foot-wide (900-mm)

strip of modified bitumen sheet that replaces the lowest course of asphalt-saturated felt paper. The bitumen self-seals around the shanks of the roofing nails as they are driven through it.

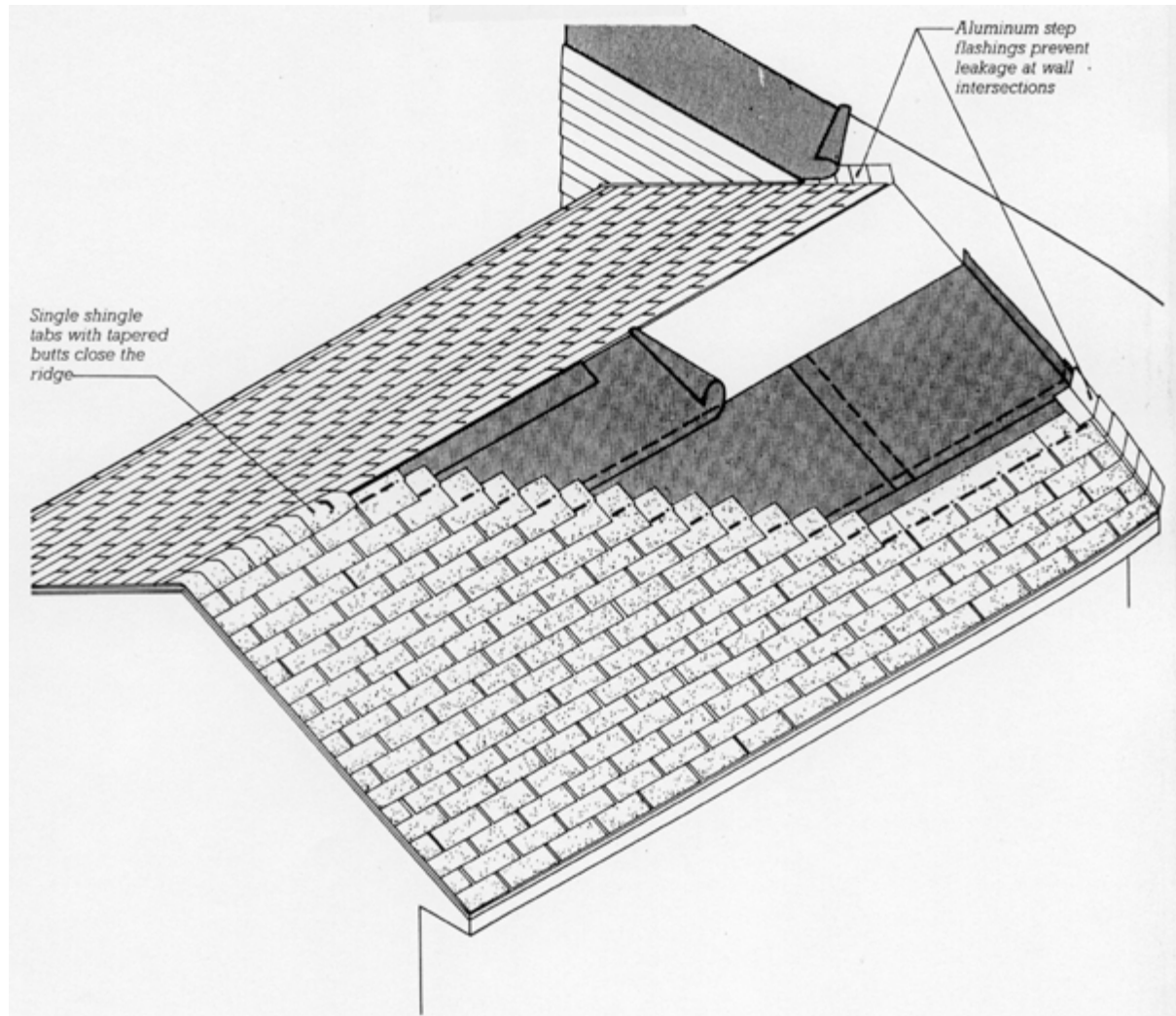
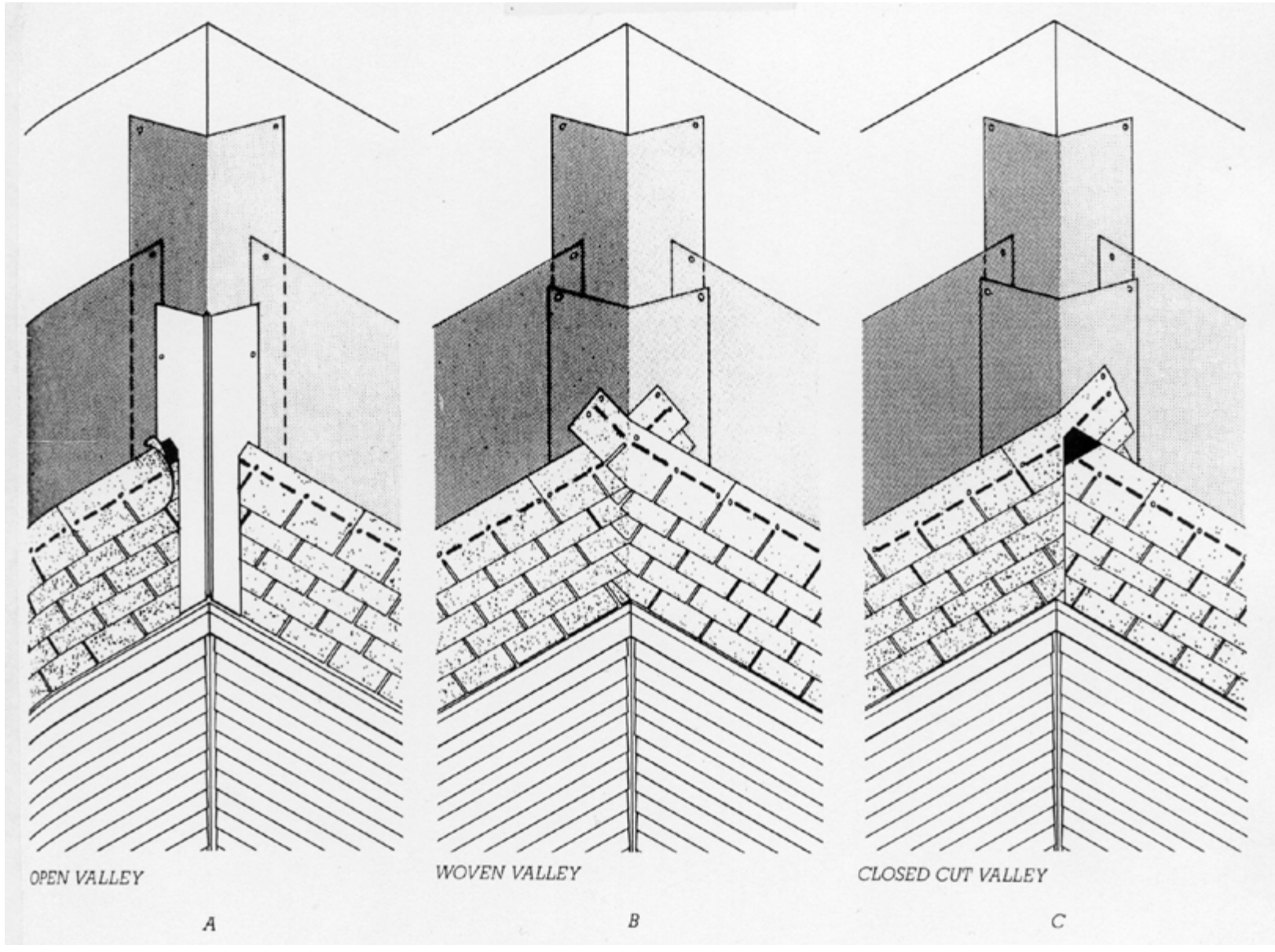

FIGURE 13.43
Completing an asphalt shingle roof. A metal attic-ventilation strip is often substituted for the single-tab shingles on the ridge.

Pitched Roof: Shingle Ridge Detail



Pitched Roof: Shingle Valley Detail



Keep the valley clear and easy for water to drain.

CLOSED CUT VALLEY

DIAGRAM 1

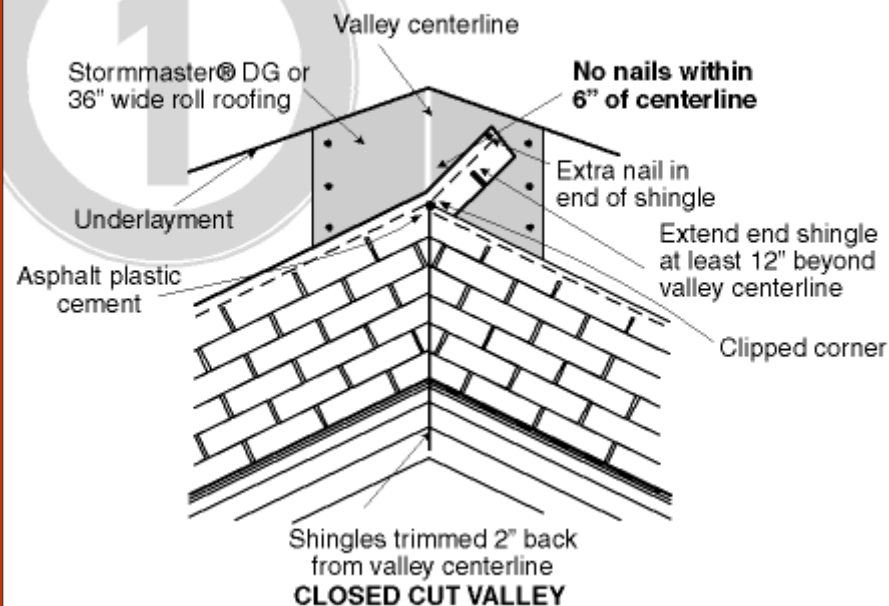

WOVEN VALLEY

DIAGRAM 2

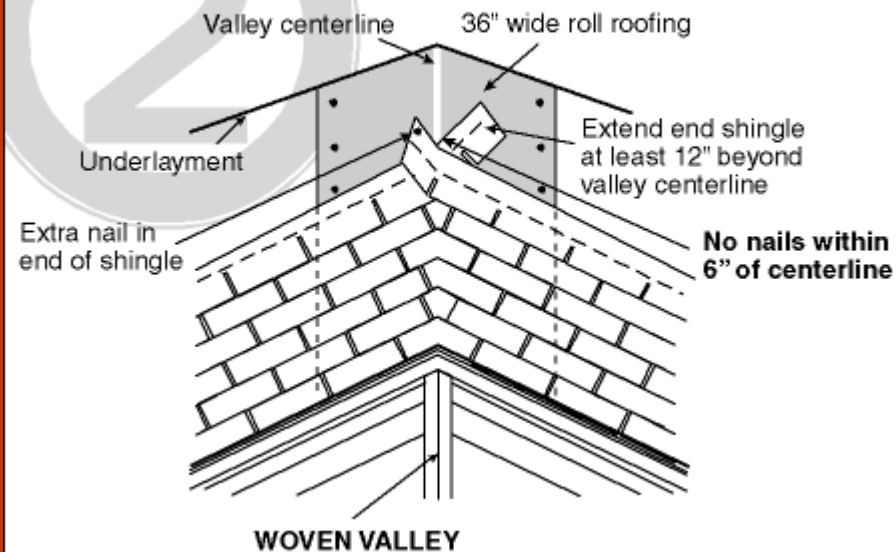

OPEN VALLEY

DIAGRAM 3

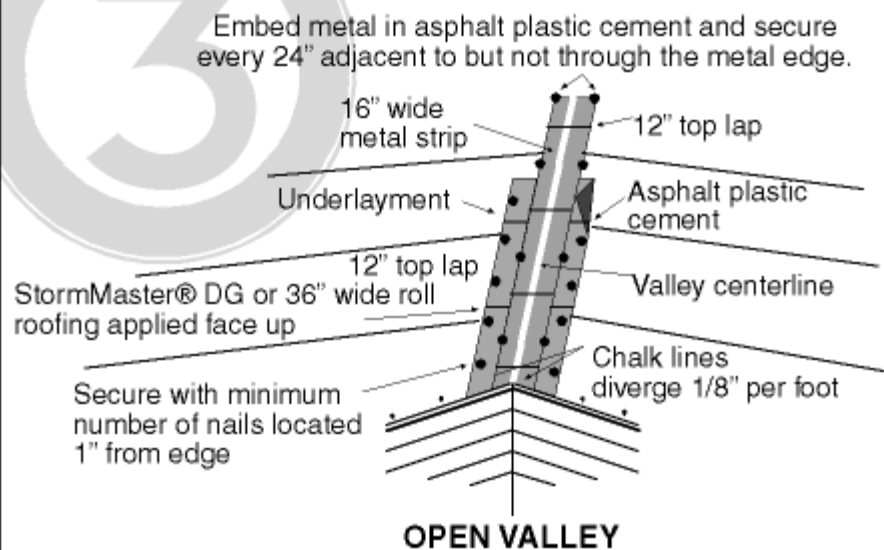

STARTER COURSE

DIAGRAM 5

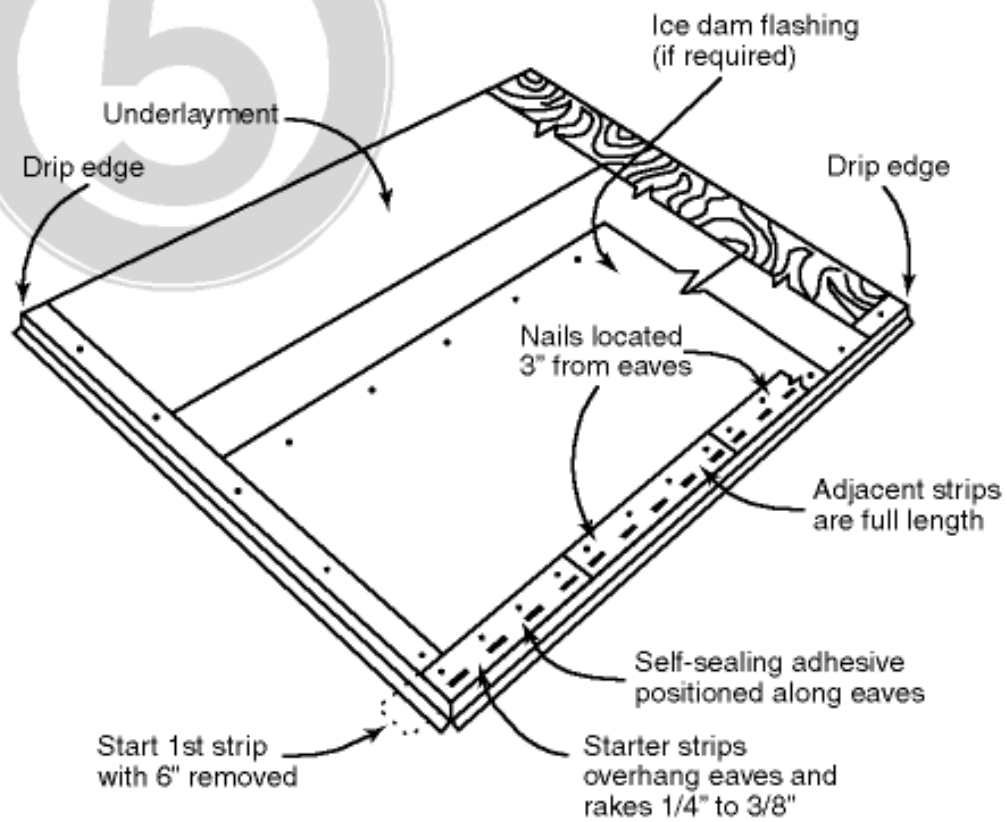

FOURTH COURSE

DIAGRAM 6

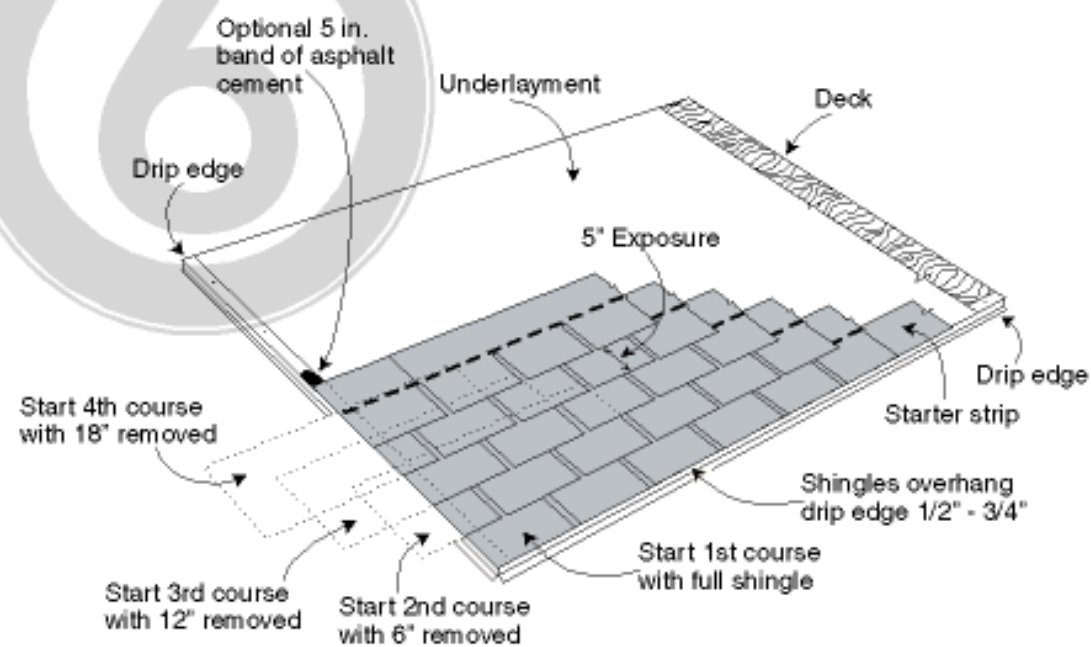

CEMENT APPLICATION

DIAGRAM 7

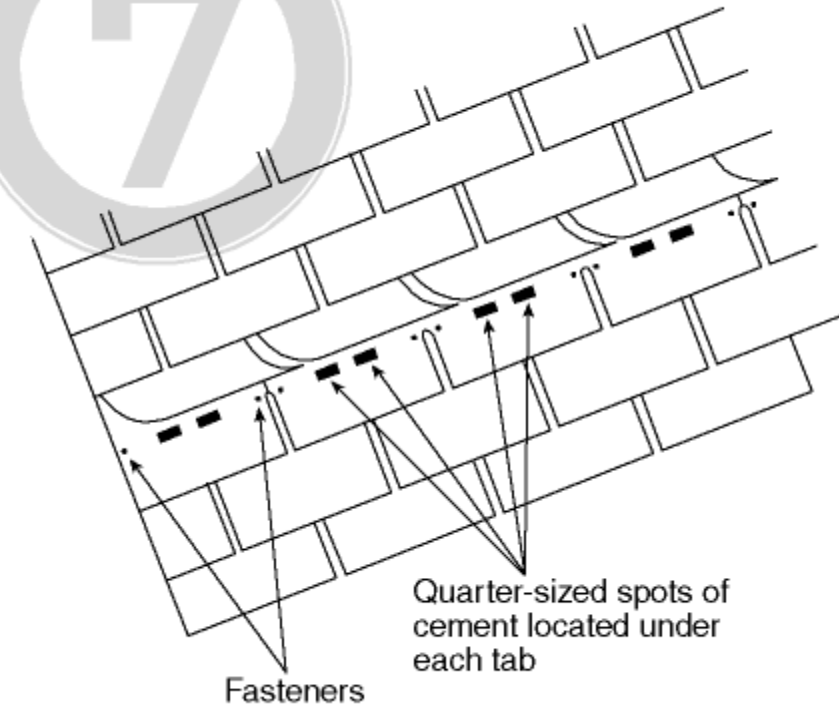

FASTENER LOCATIONS

DIAGRAM 4

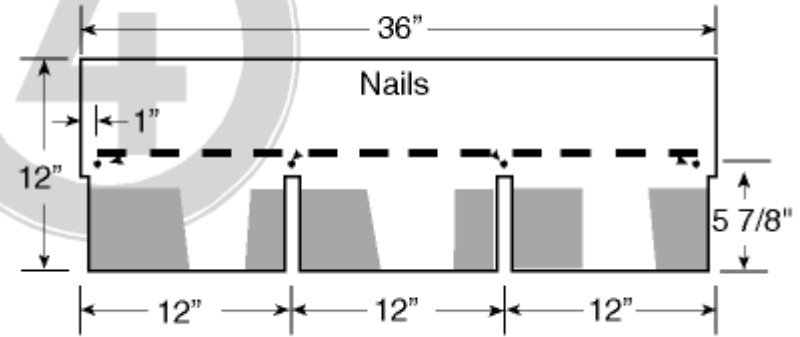

HIP & RIDGE

DIAGRAM 8

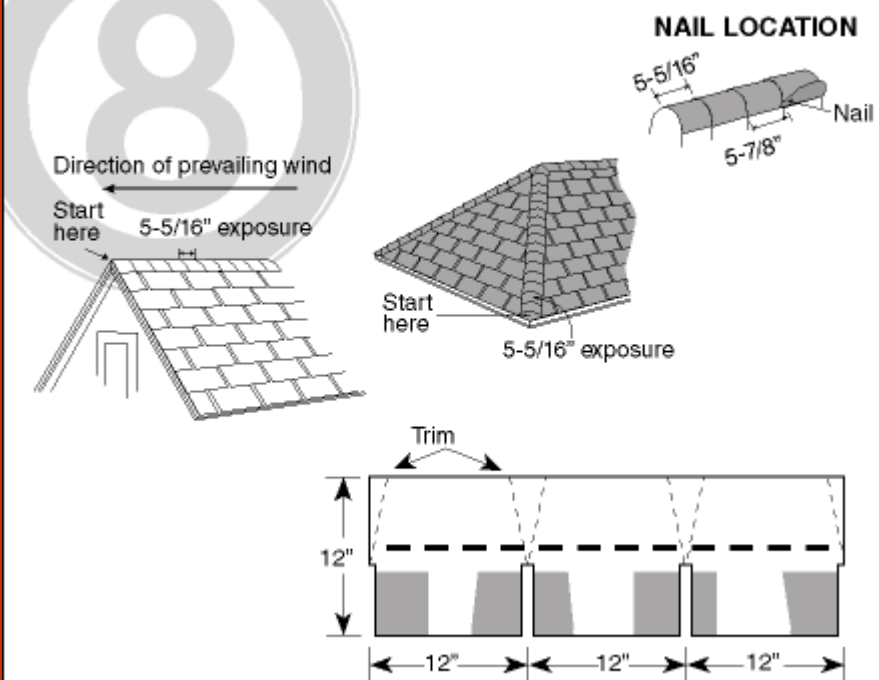

Roof felt

Shingle line

Vent pipe flashing

Valley flashing

Drip edge

**Chimney base
flashing**

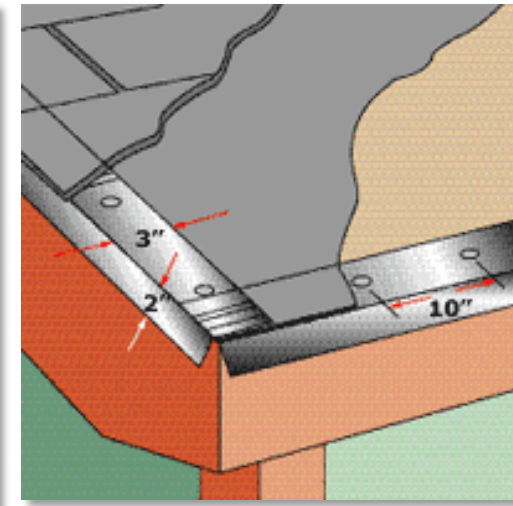
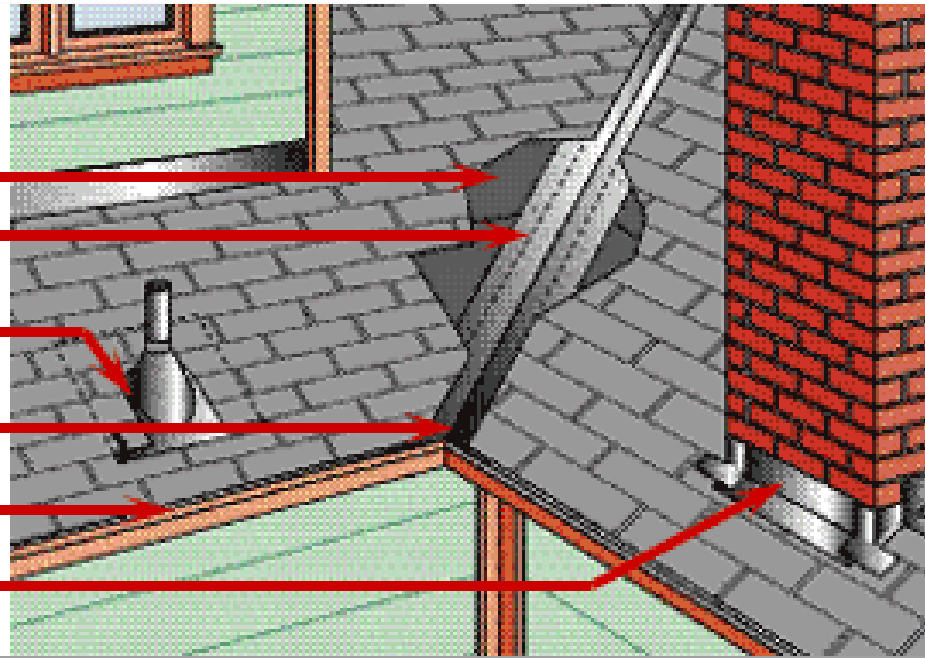

**Cap flashing (shown
bent upward)**

Mortar joints

Step flashing

Cap flashing

Base flashing

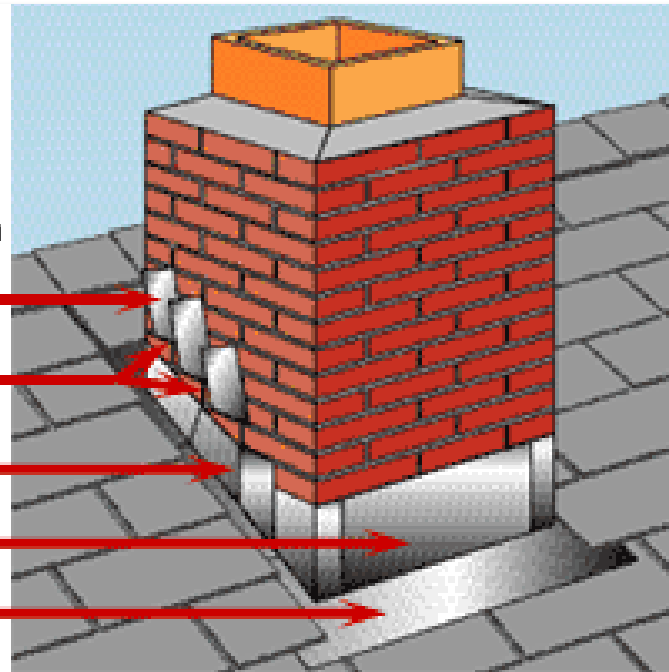

Asphalt flashing
details



A saddle is used to divert water around the chimney



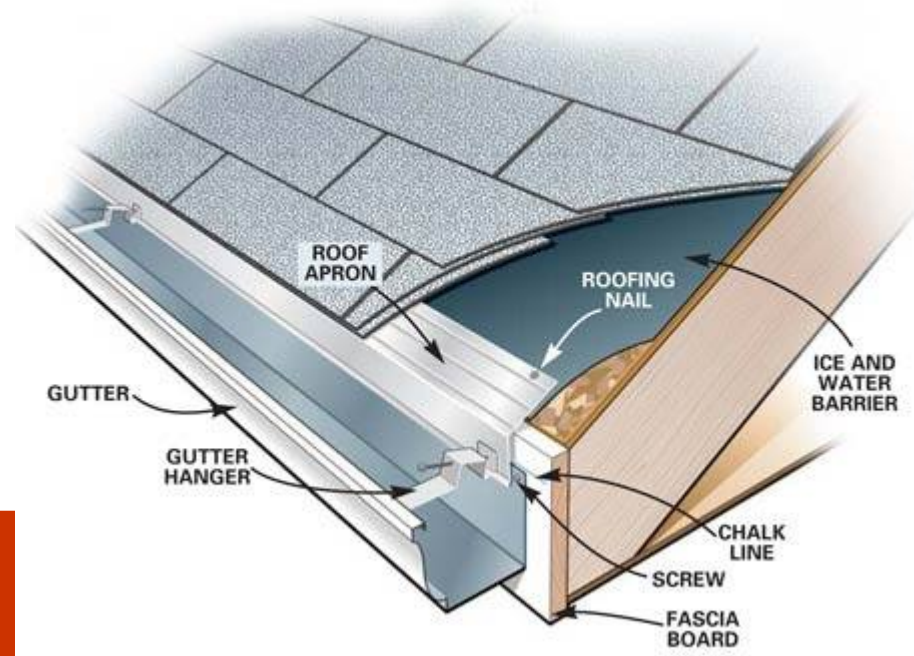



Ice and water shield being installed at the bottom meter of a shingled roof. Note that it is lapped UNDER the roofing paper to promote drainage. This extra membrane is thicker and more durable than roofing paper and is meant to prevent water leakage due to "ice dams" at the end of the roof.

Eave protection against ice dams

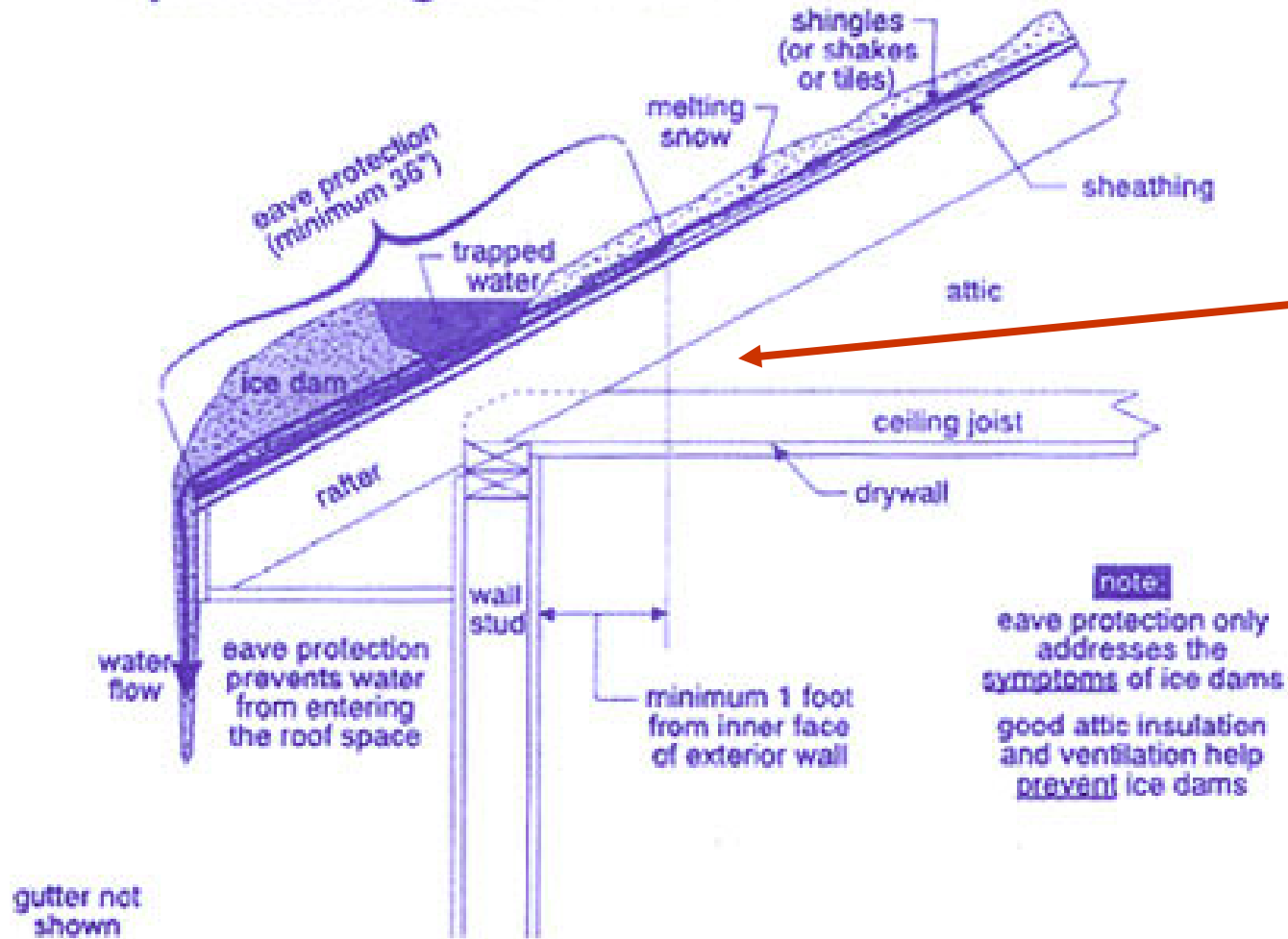
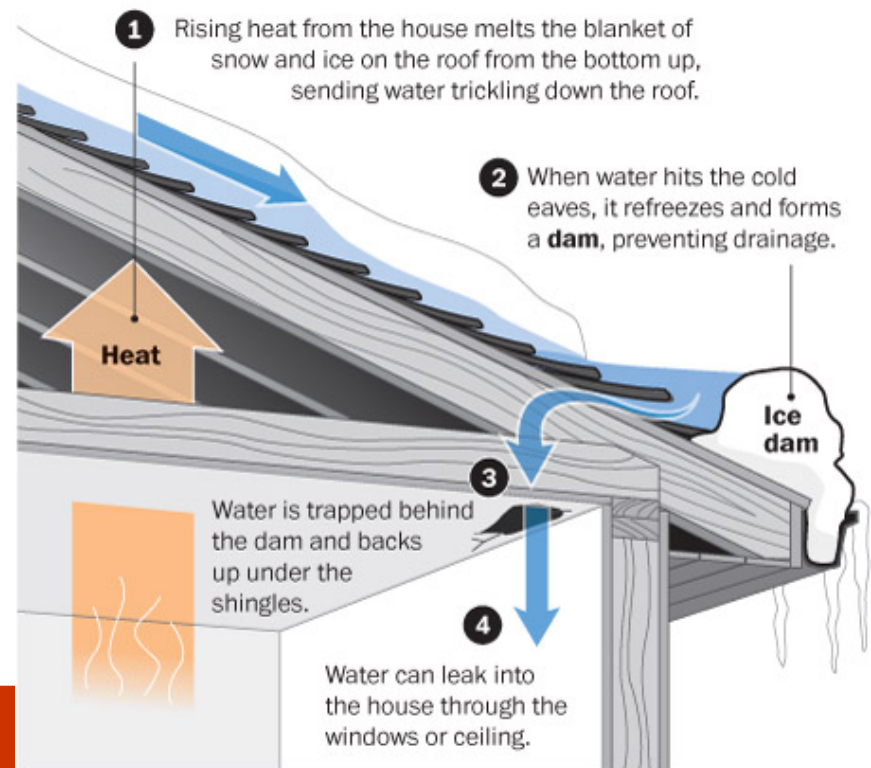
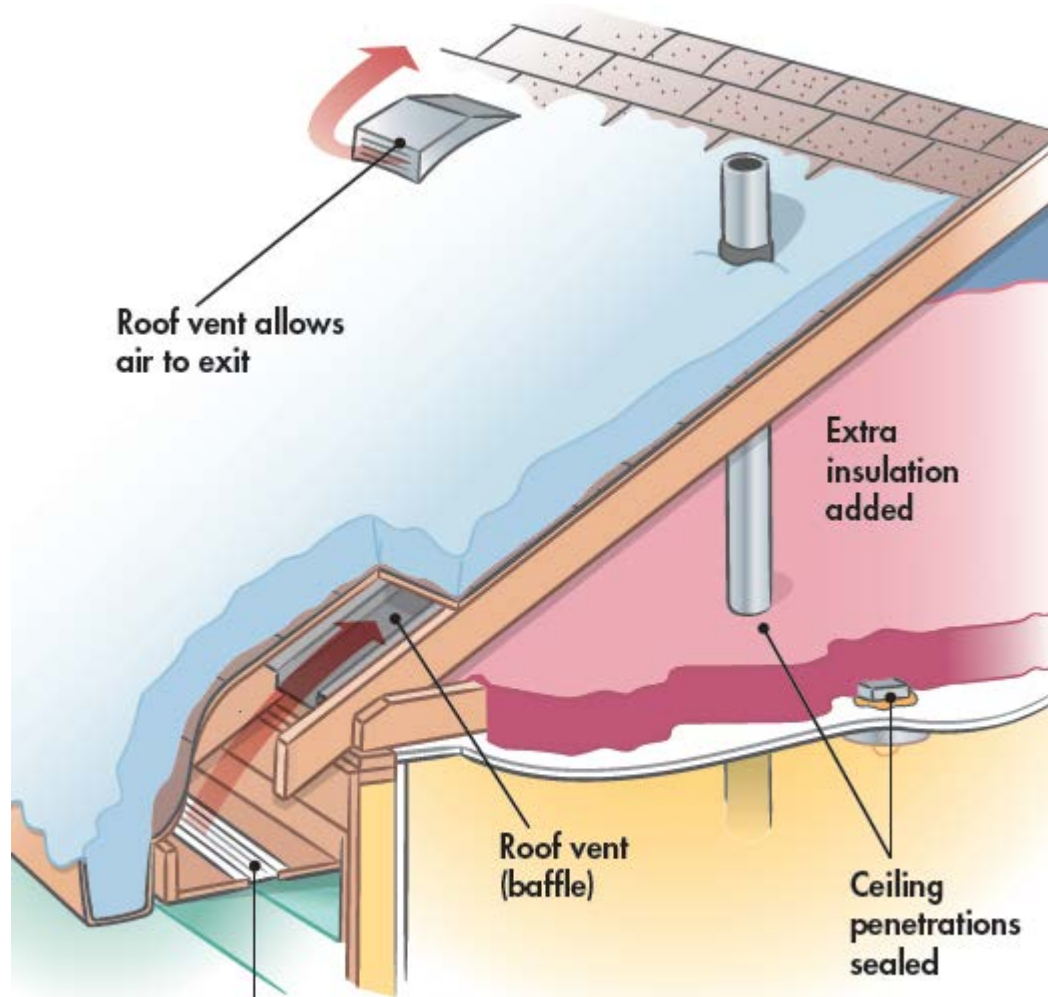

Figure 5. Ice Damming

Ice Dams

Note:
insulation
missing in
this
diagram!!

So important
to watch for
technical
mistakes on
diagrams in
books!



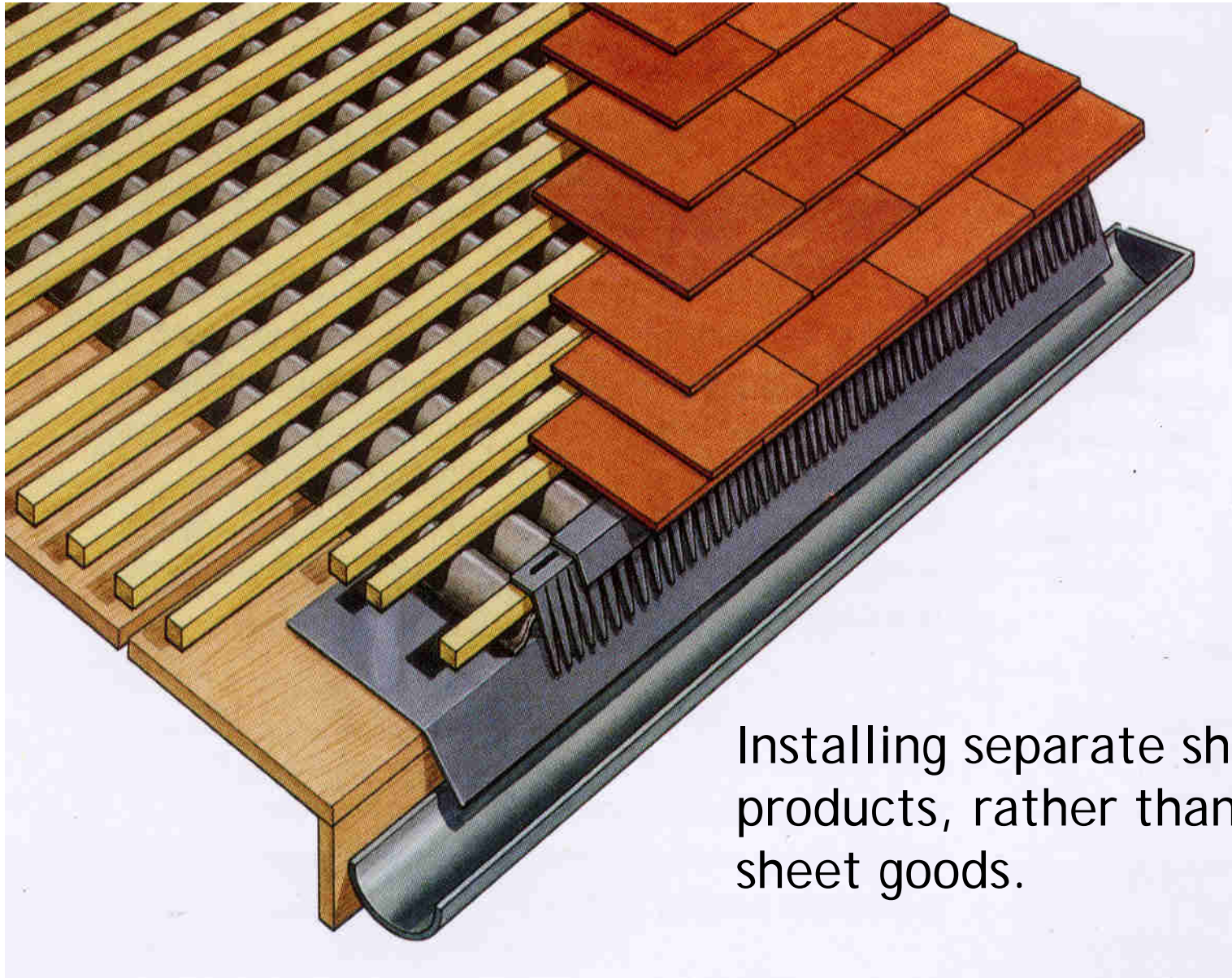

Installing separate shingle products, rather than sheet goods.

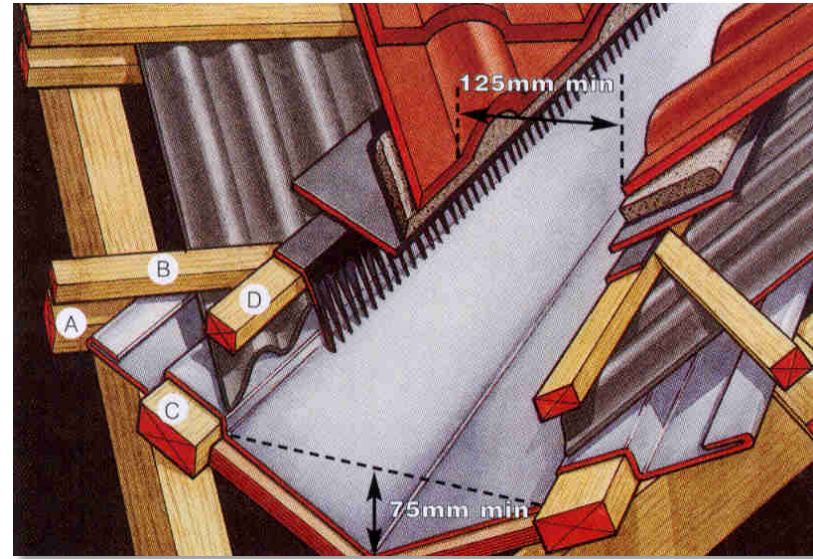
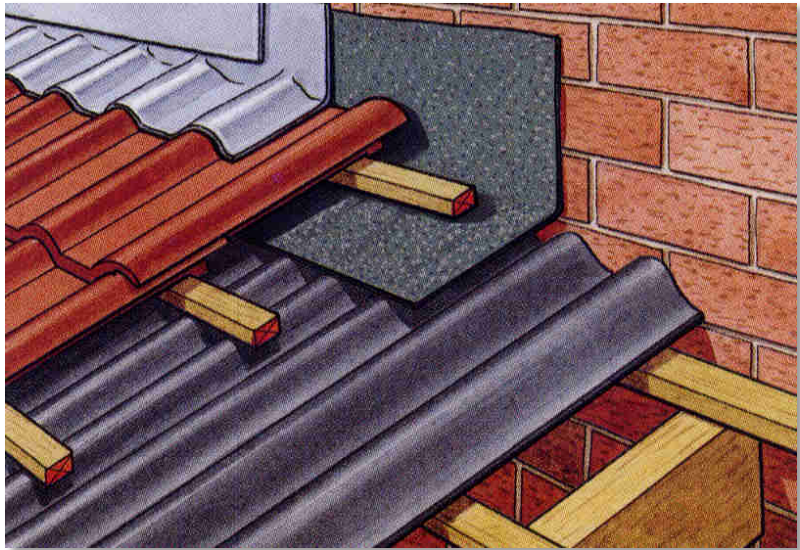
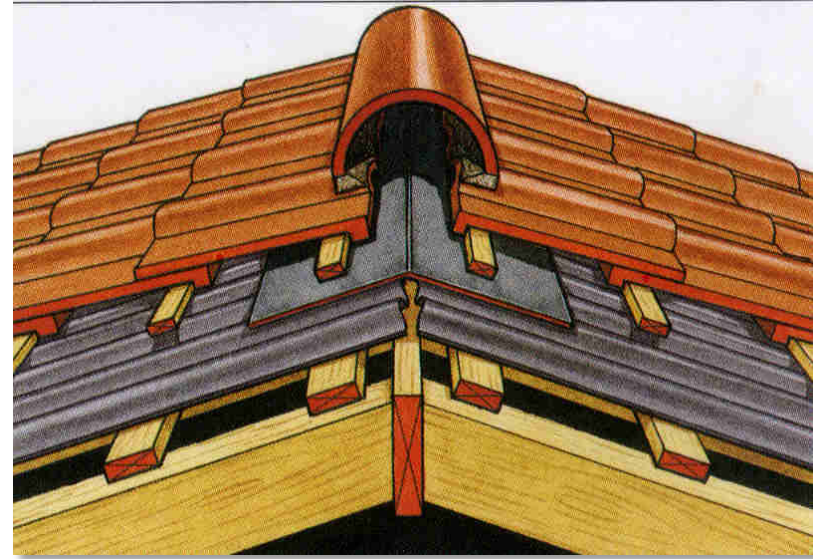
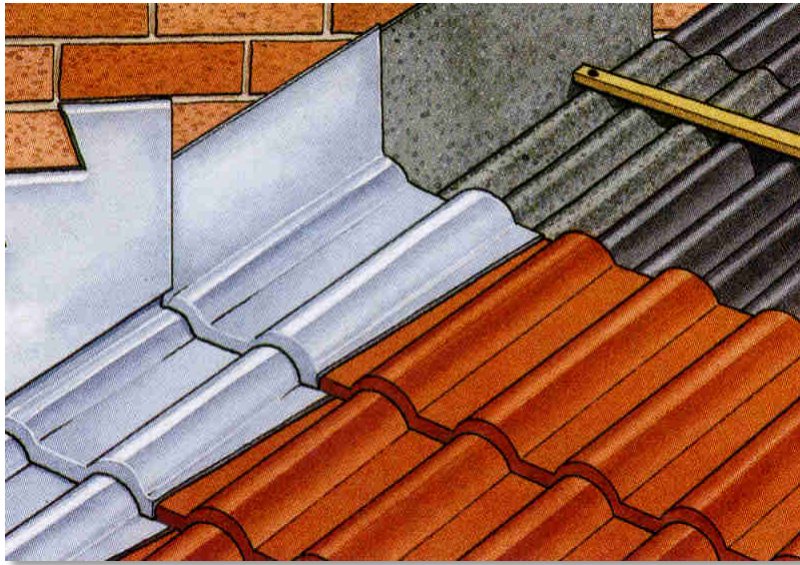

Installation details for tile products.

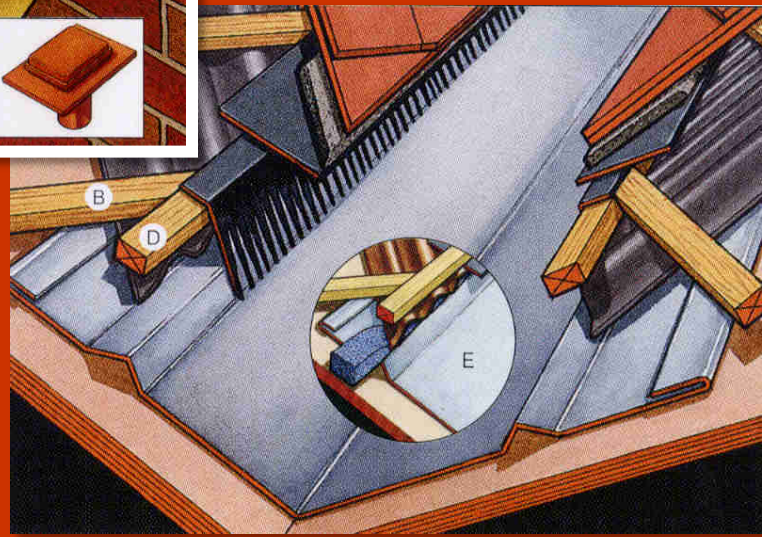
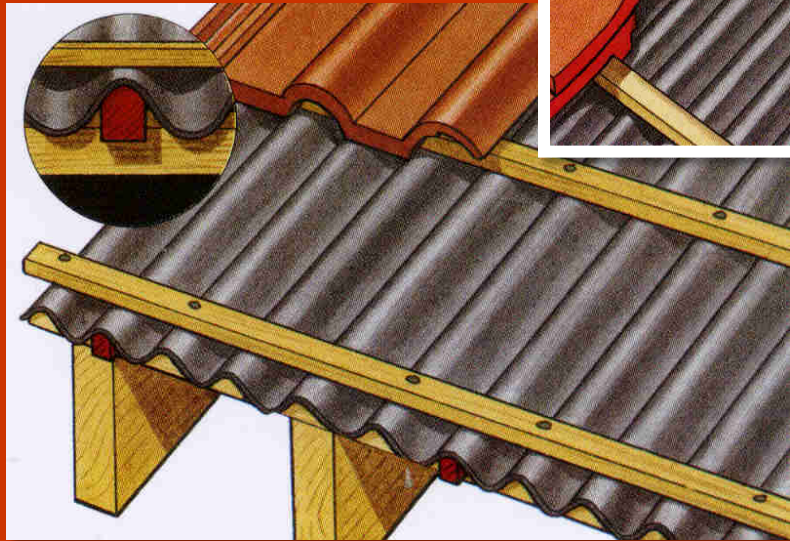
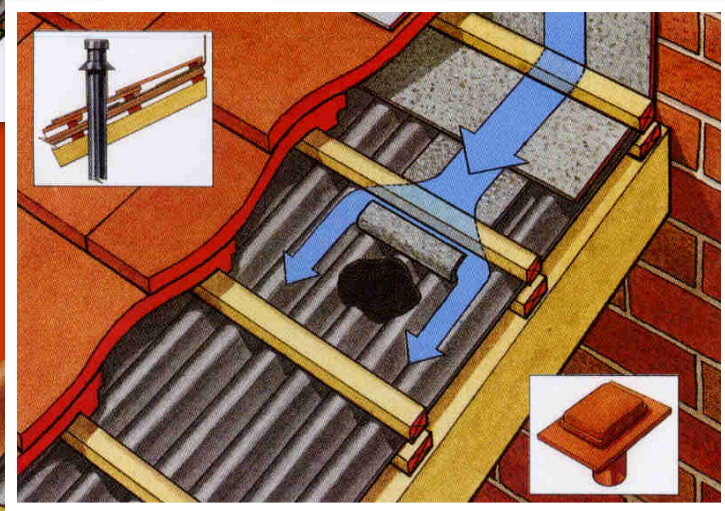
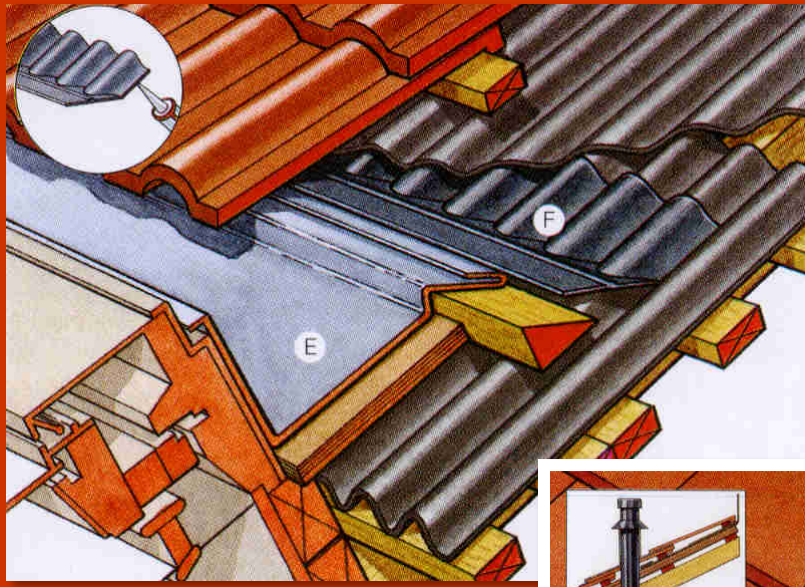



Batten mounted steel roof.



Contemporary tile look roof with underlayment



Larger sheet product



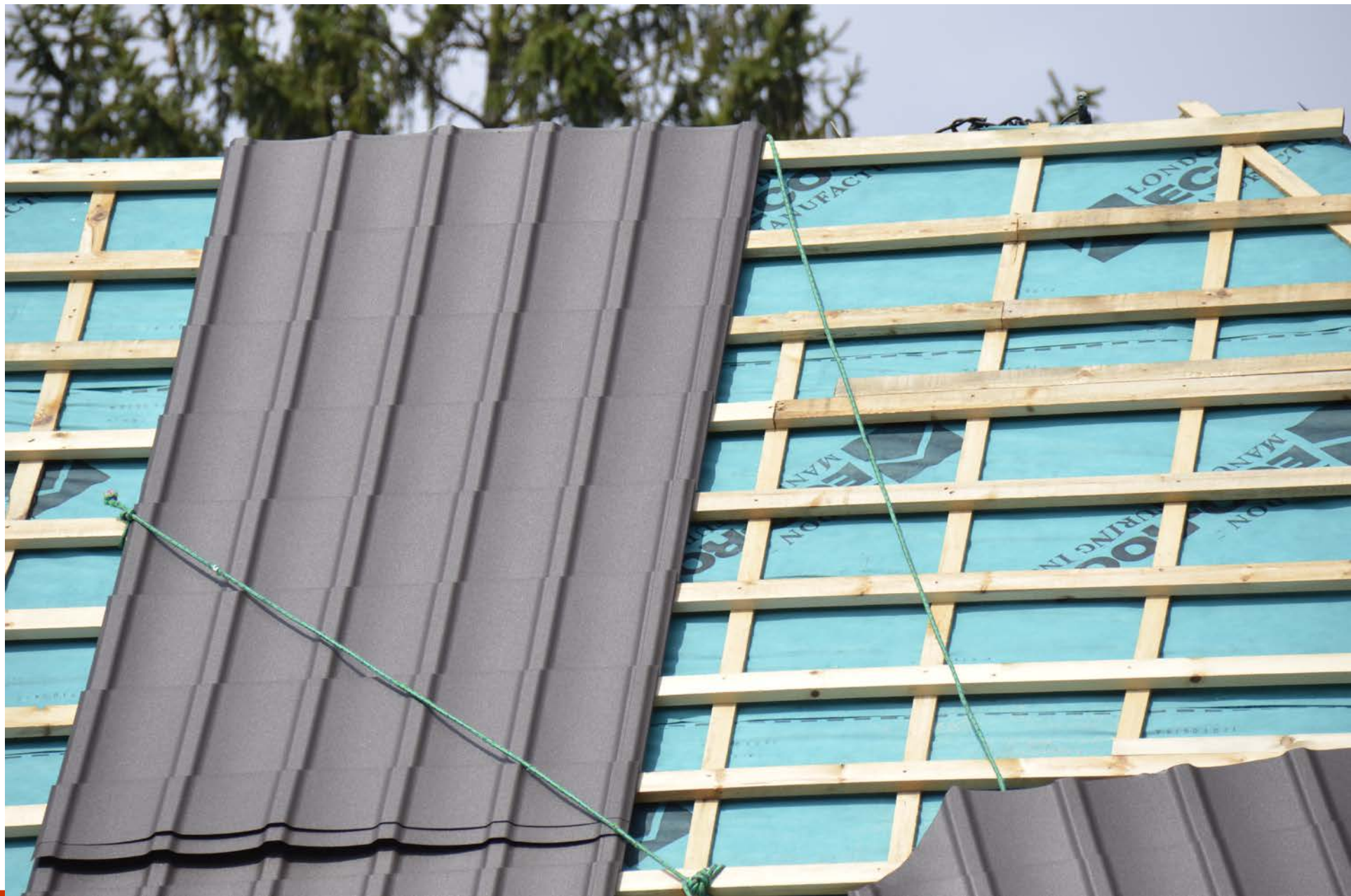



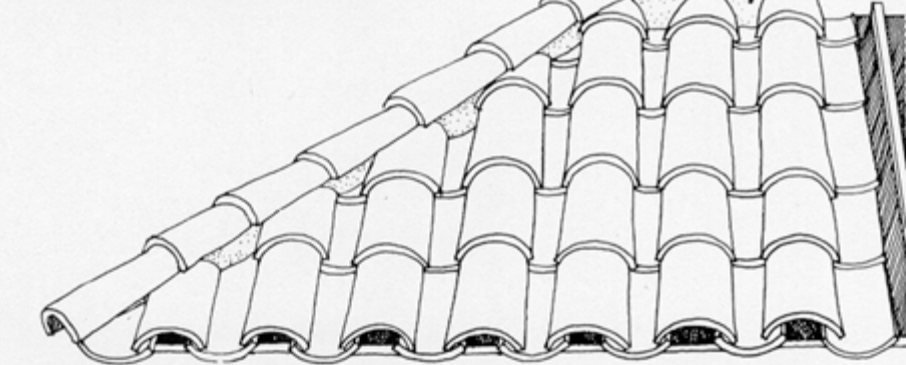
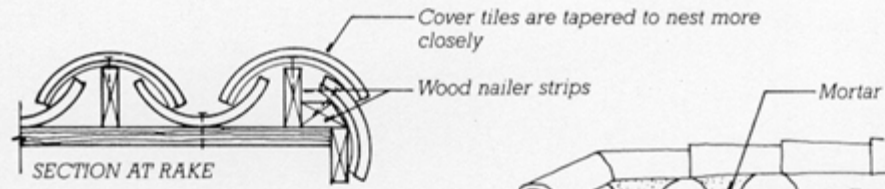

MISSION TILES

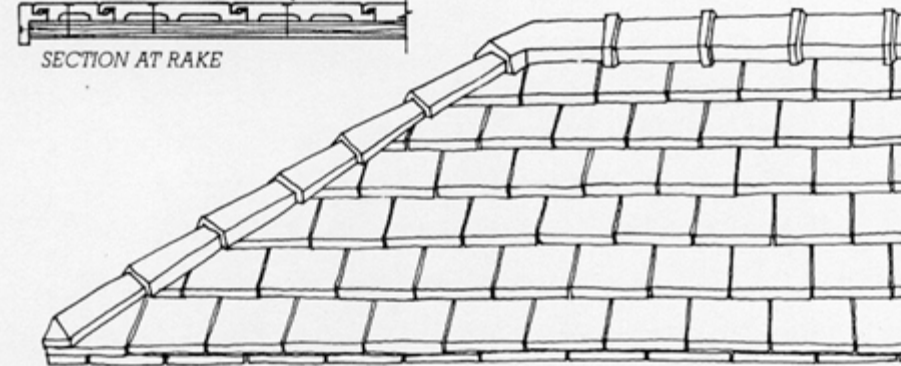
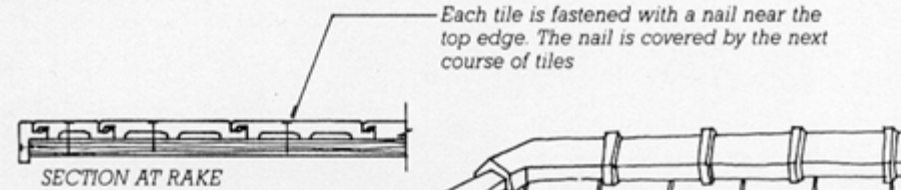

SHINGLE TILES

FIGURE 13.47
Two styles of clay tile roofs. The mission tile has very ancient origins.

Pitched Roof: Clay Tiles



Vatican, Rome



Vatican, Rome



Summer Palace, Beijing, China

Chinese roof decoration / roof charms / roof-figures: The number of animals, between the two figures indicates the importance of the building. The maximum number of beasts is nine. At the tail of the procession will be an imperial dragon, representing the authority of the state.



Forbidden City, Beijing, China



Historic housing, Beijing, China

How clay tiles are secured

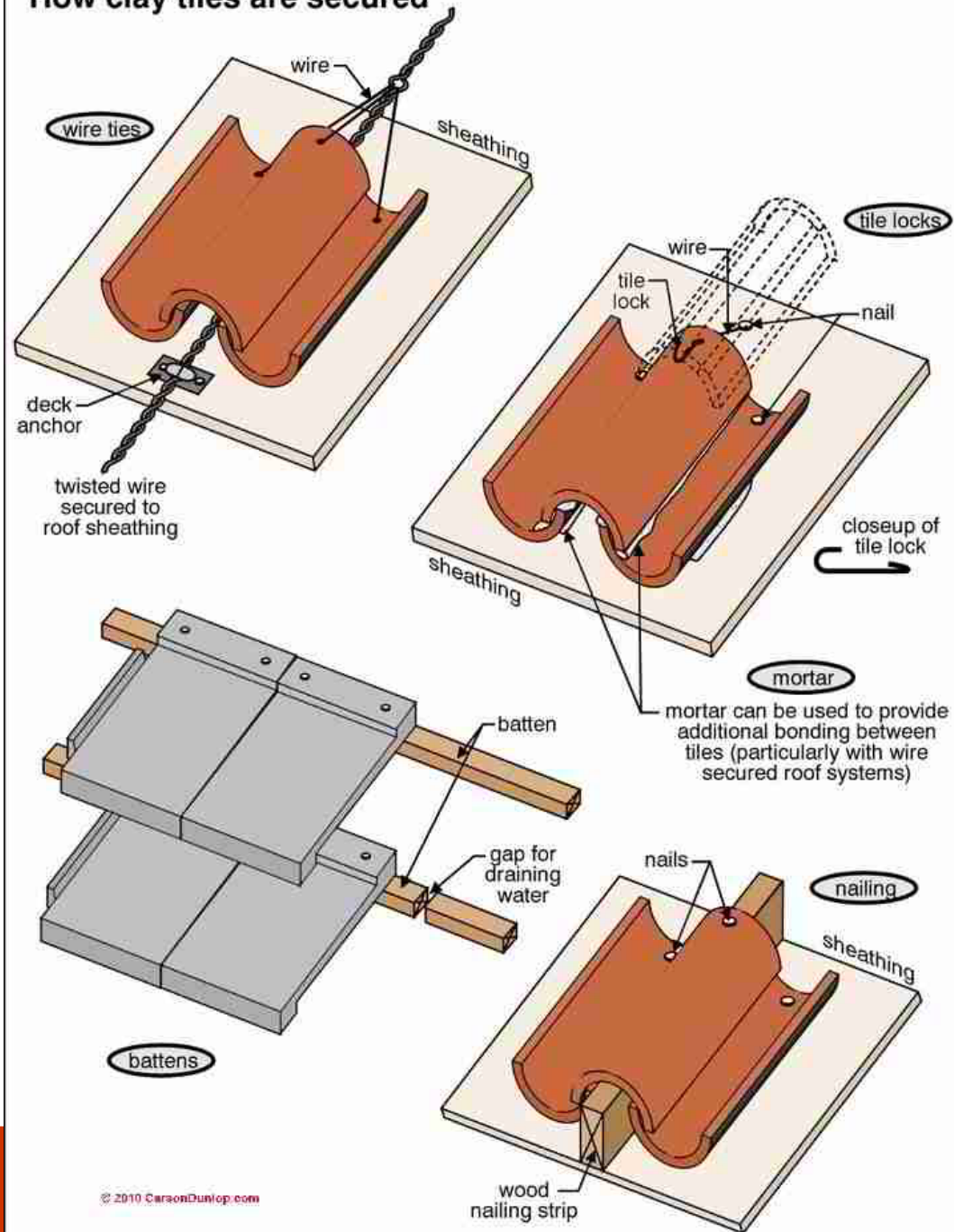

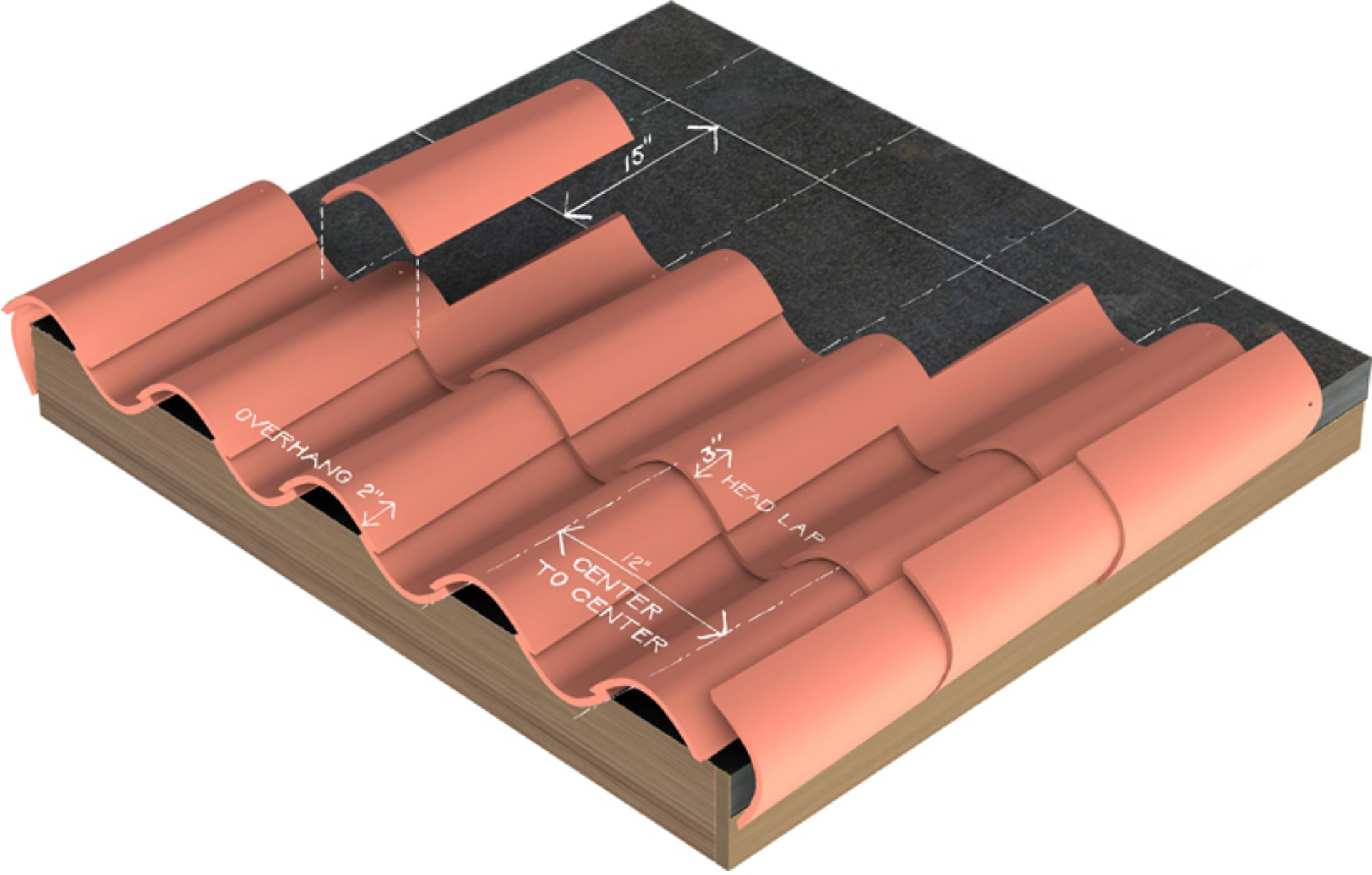





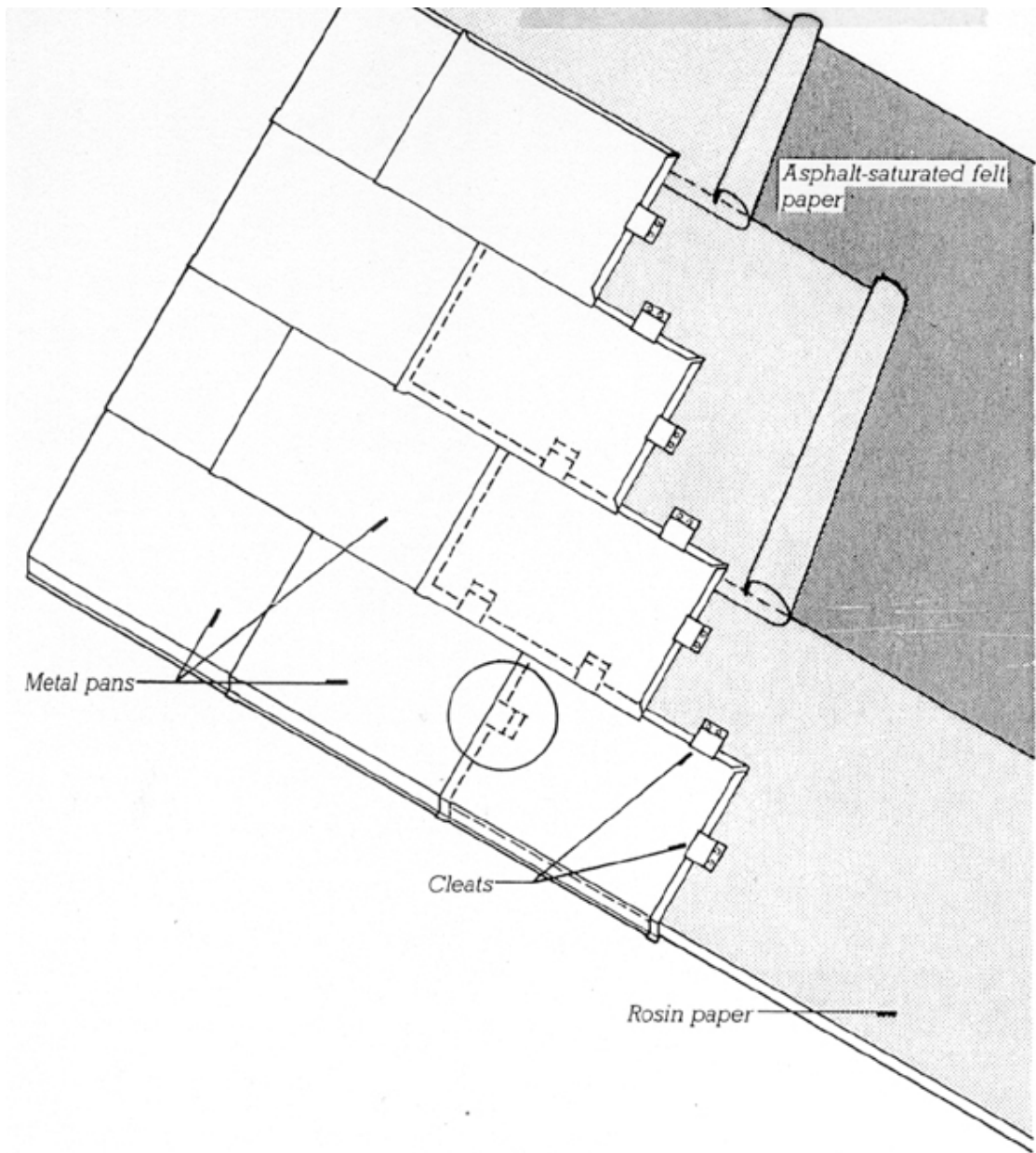

FIGURE 13.50

Installing a flat-seam metal roof. The three diagrams at the bottom of the illustration show the three steps in creating the seam, viewed in cross section. The cleats, which fasten the roofing to the deck, are completely concealed when the roof is finished.

Metal Roof: Flat Seam



Step 1: Each pan is formed in the sheetmetal shop with folded edges.

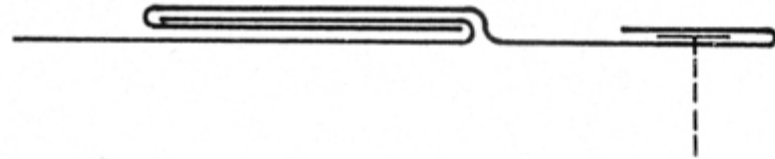

Step 2: Sheet metal cleats interlock with the folded edges and are nailed to the deck. The cleat is folded back over the nail head to protect the pan.

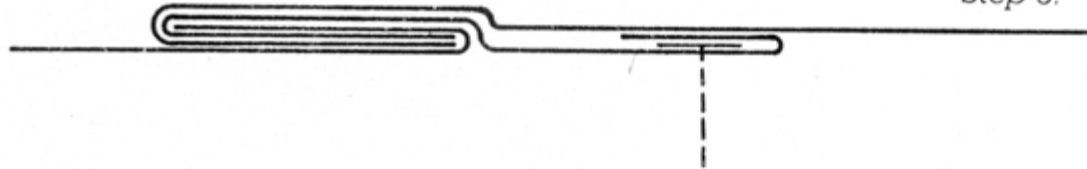

Step 3: The next pan is interlocked with the first. When all pans are in place, the edges are beaten flat and soldered or sealed.

Metal Roof: Flat Seam





The Gehry Weisman Art Museum in Minneapolis used similar techniques for the stainless steel cladding panels.

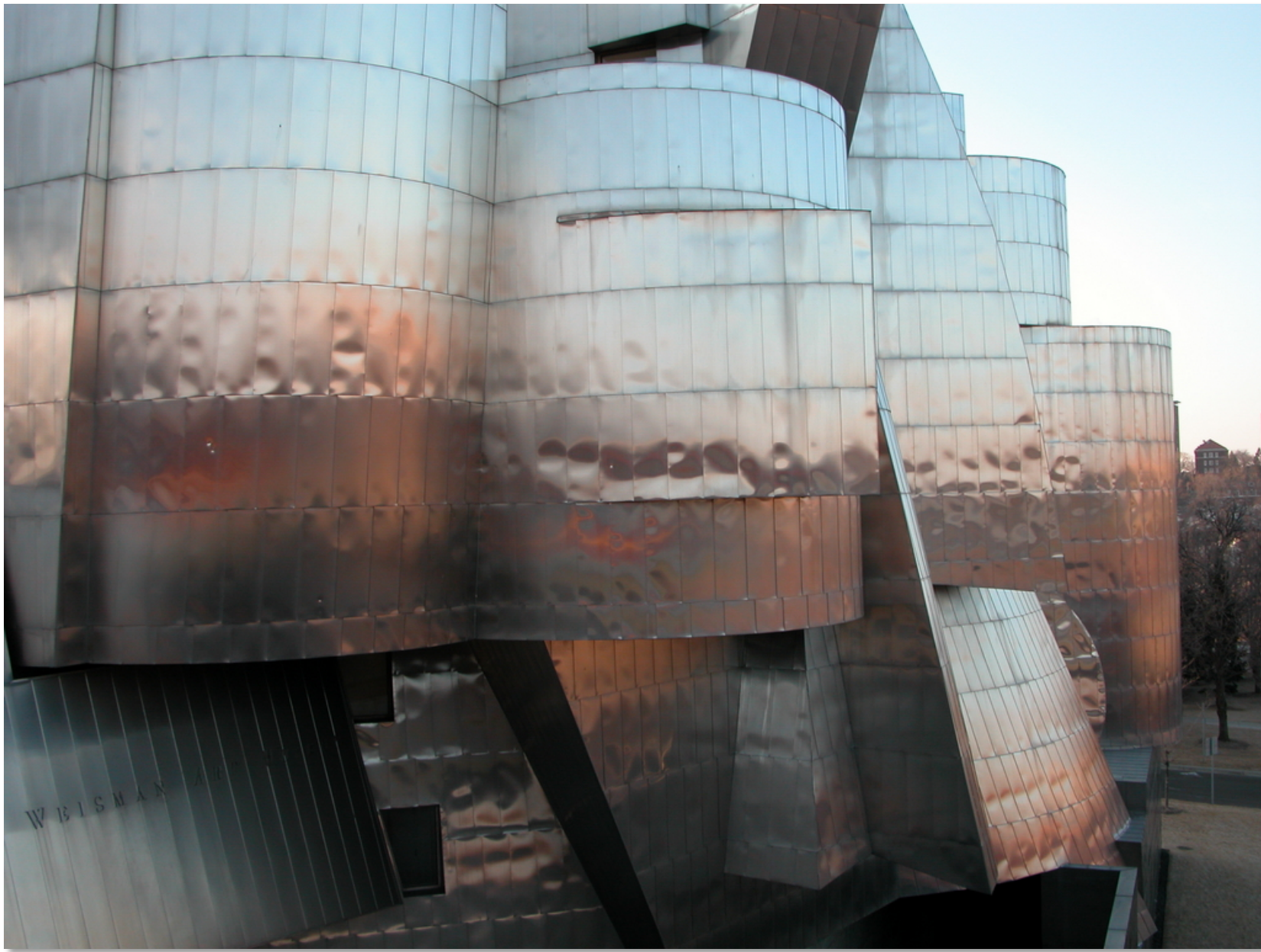

The Gehry Weisman Art Museum in Minneapolis used similar techniques for the stainless steel cladding panels.

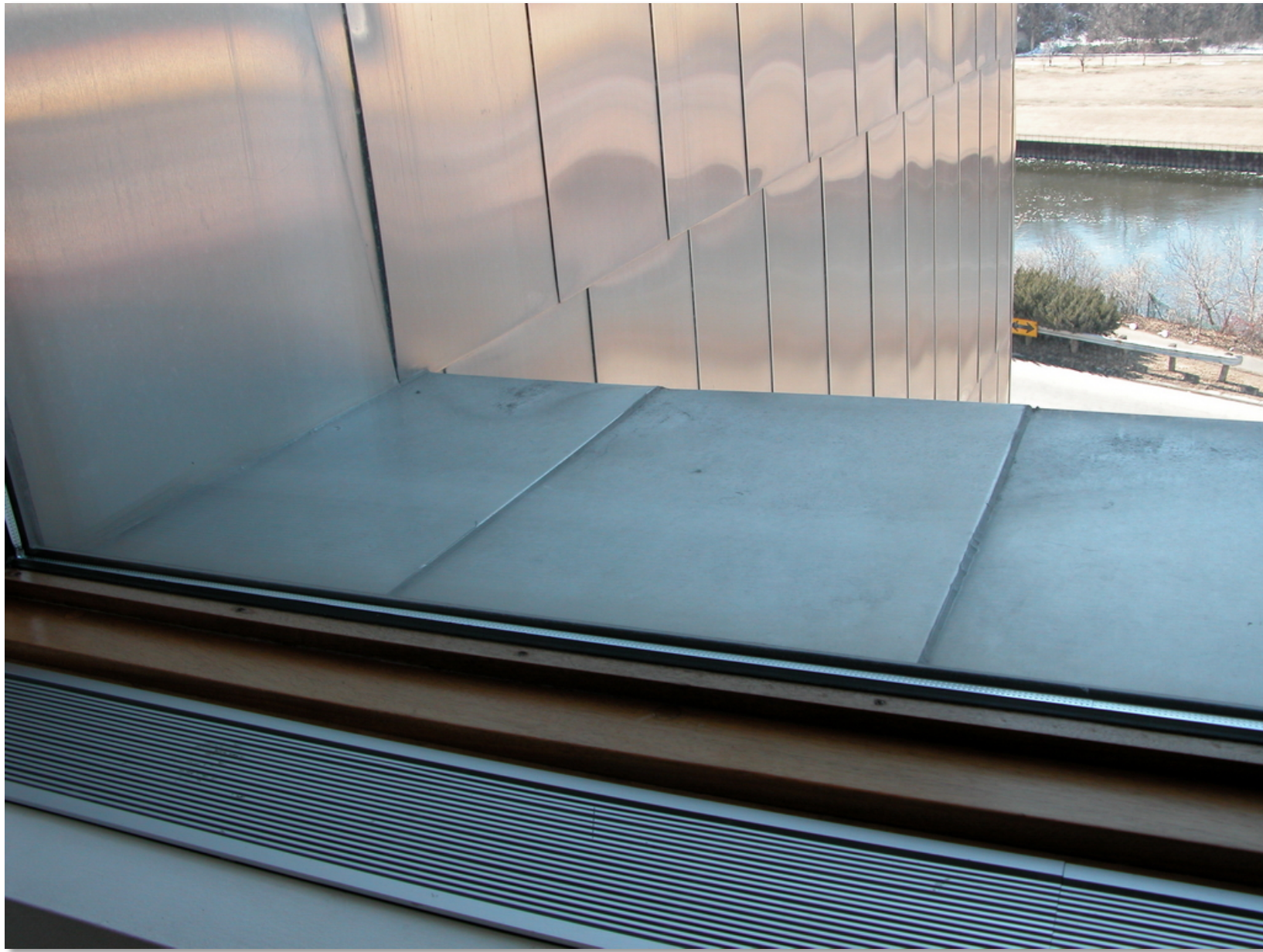

Although here you can see for the flat window ledge detail that a sealant has been used to prevent water penetration. NOT the best solution! Slope to drain is ALWAYS more reliable



Walt Disney Concert Hall, Frank Gehry

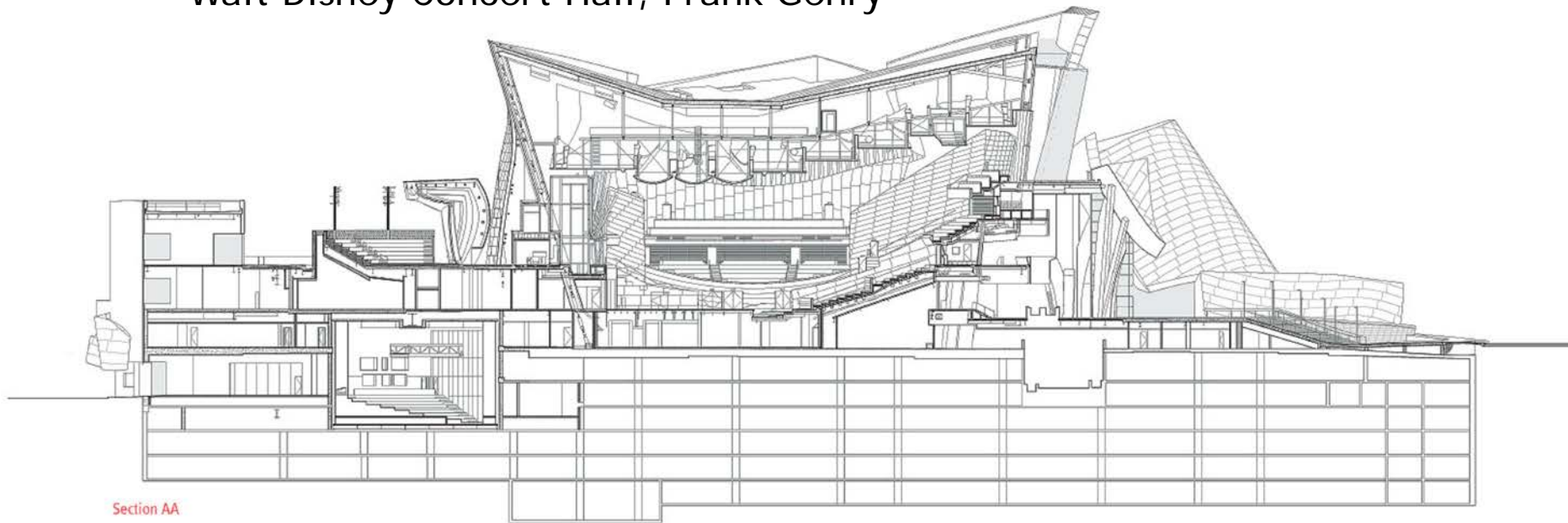

Section AA

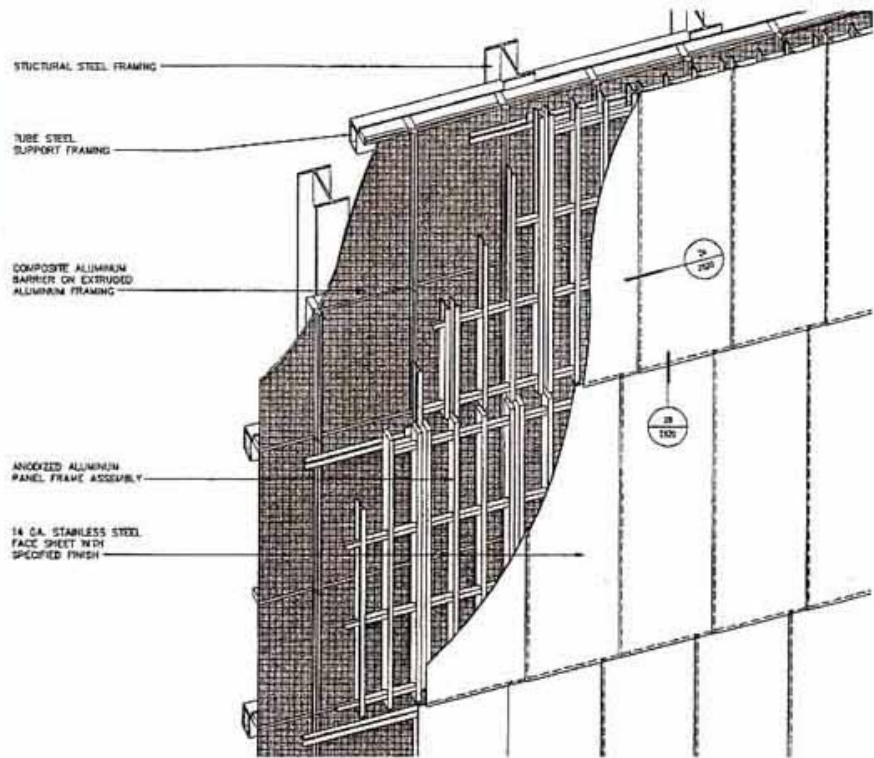

5 METAL PANEL ASSEMBLY - TYPE 5
NOT TO SCALE

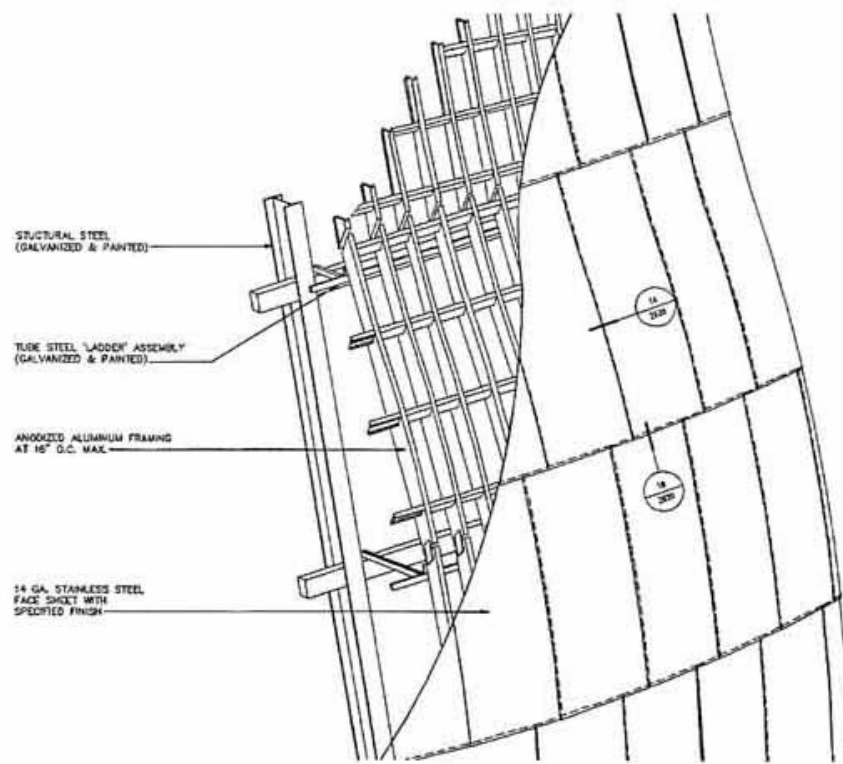

3 METAL PANEL ASSEMBLY - TYPE 3
NOT TO SCALE



Residences, Colorado, Daniel Libeskind



Denver Art Museum Residences, Daniel Libeskind

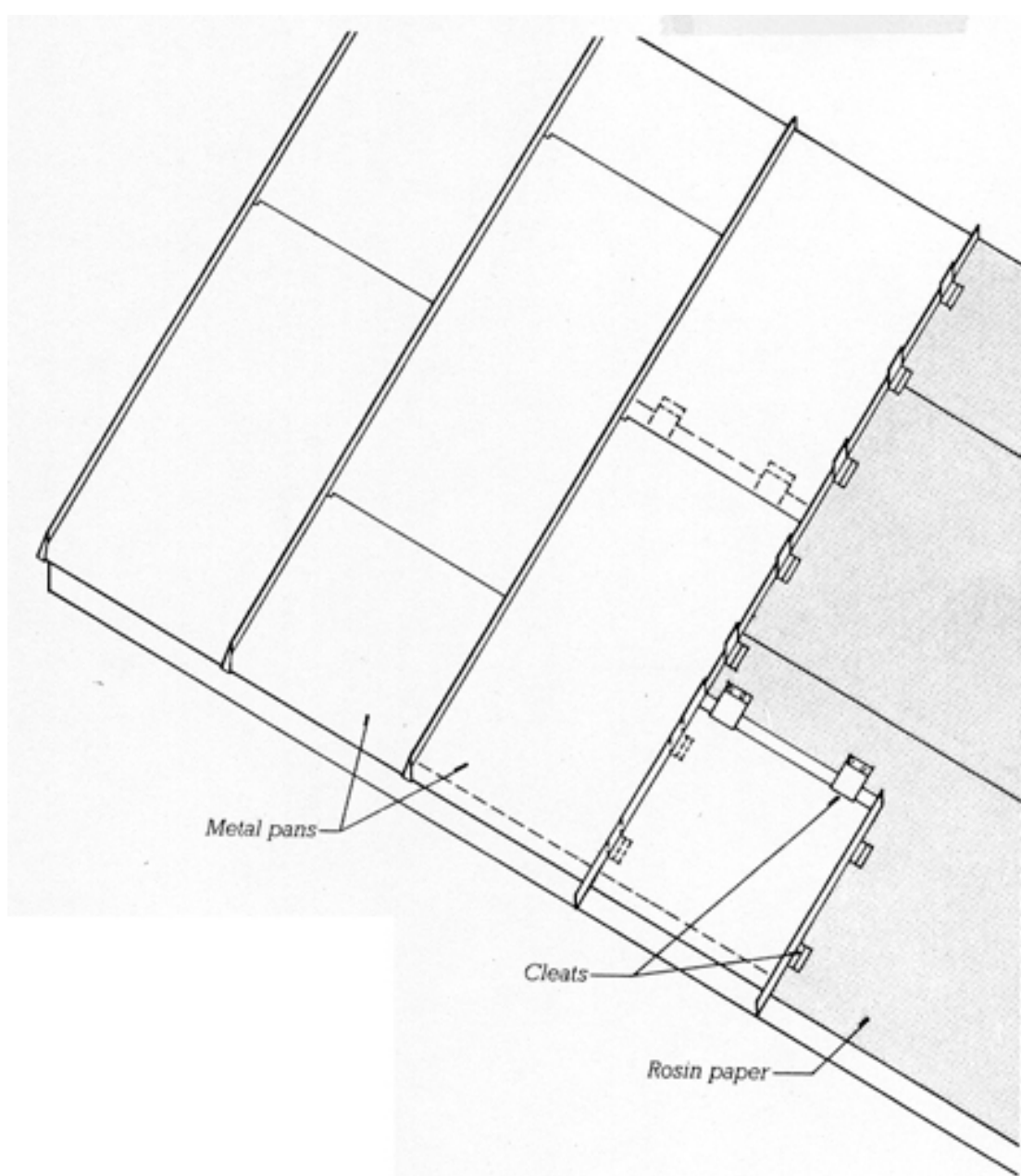
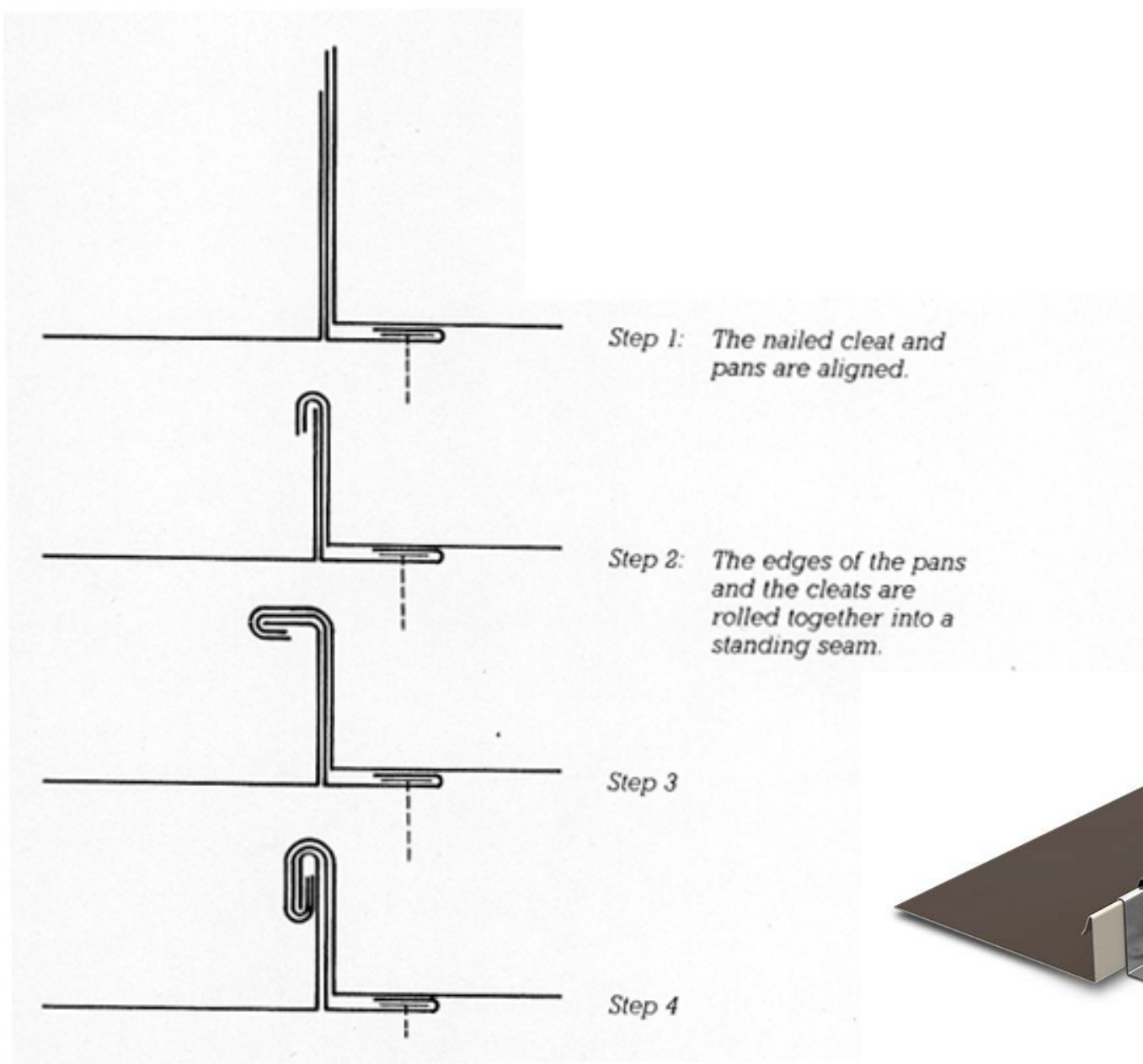

FIGURE 13.51
Installing an architectural standing-seam metal roof.

Metal Roof: Standing Seam



Metal Roof: Standing Seam





Traditional Quebec roofs (don't use shingles)



Contemporary Standing seam metal roof

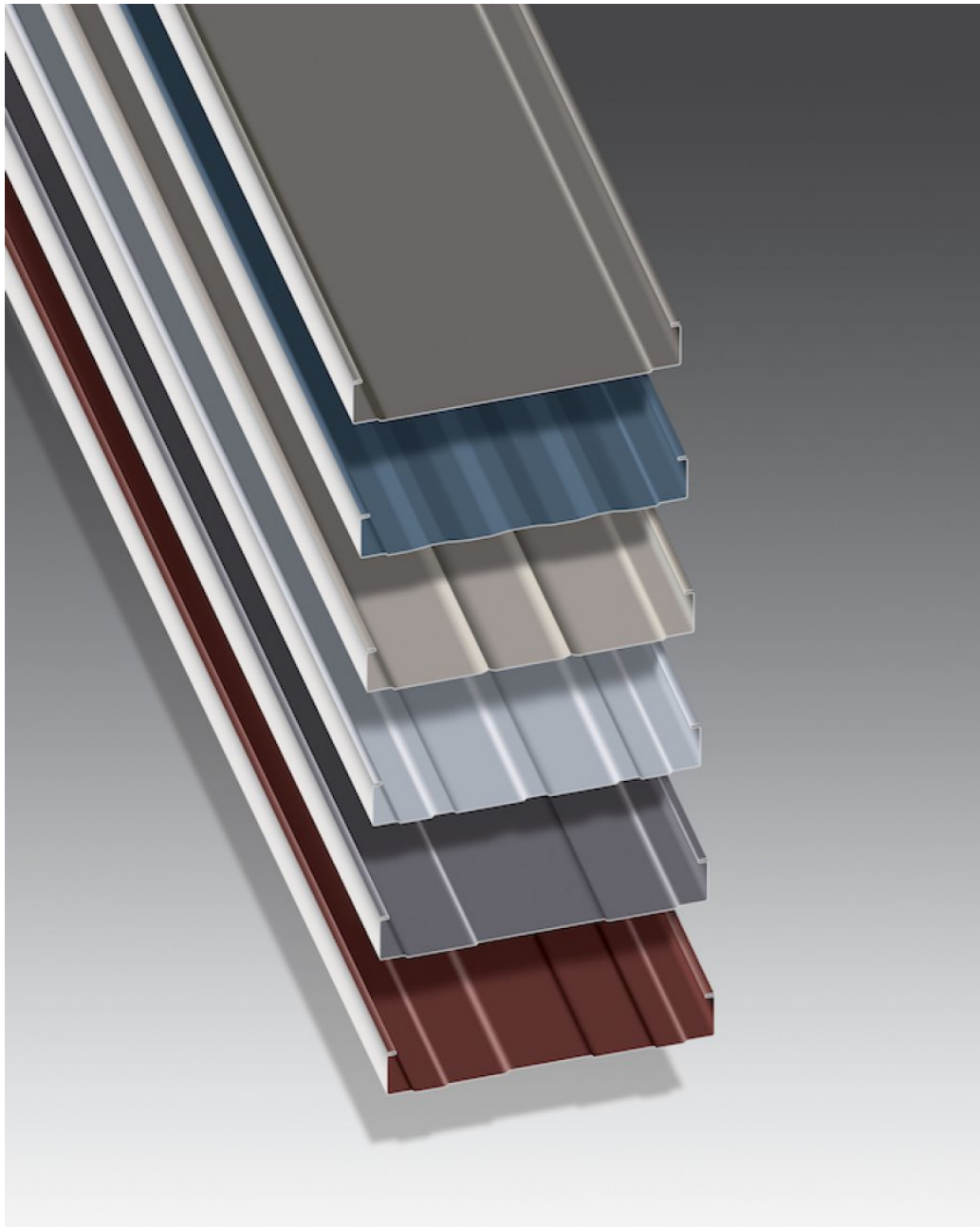

Commercial systems come in very long panels that are able to be continuous from the top to the bottom of a roof, with no need for intermediate splices as in the earthquake style that is used by Gehry.

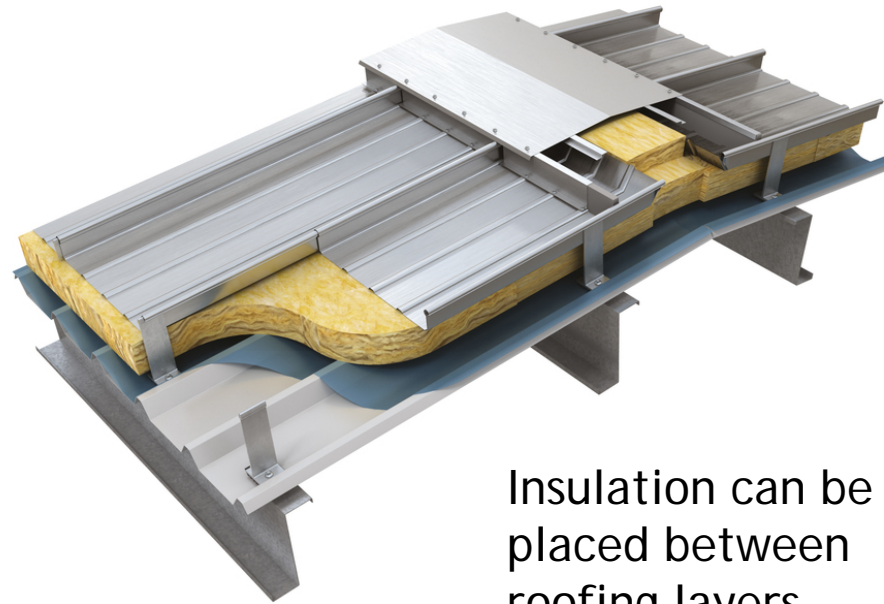

Insulation can be placed between roofing layers.





Retrofit of a commercial standing seam roof over an existing roof.





The long panels can be curved on site to fit onto curved roofs.



Contemporary terne-look roof in standing seam

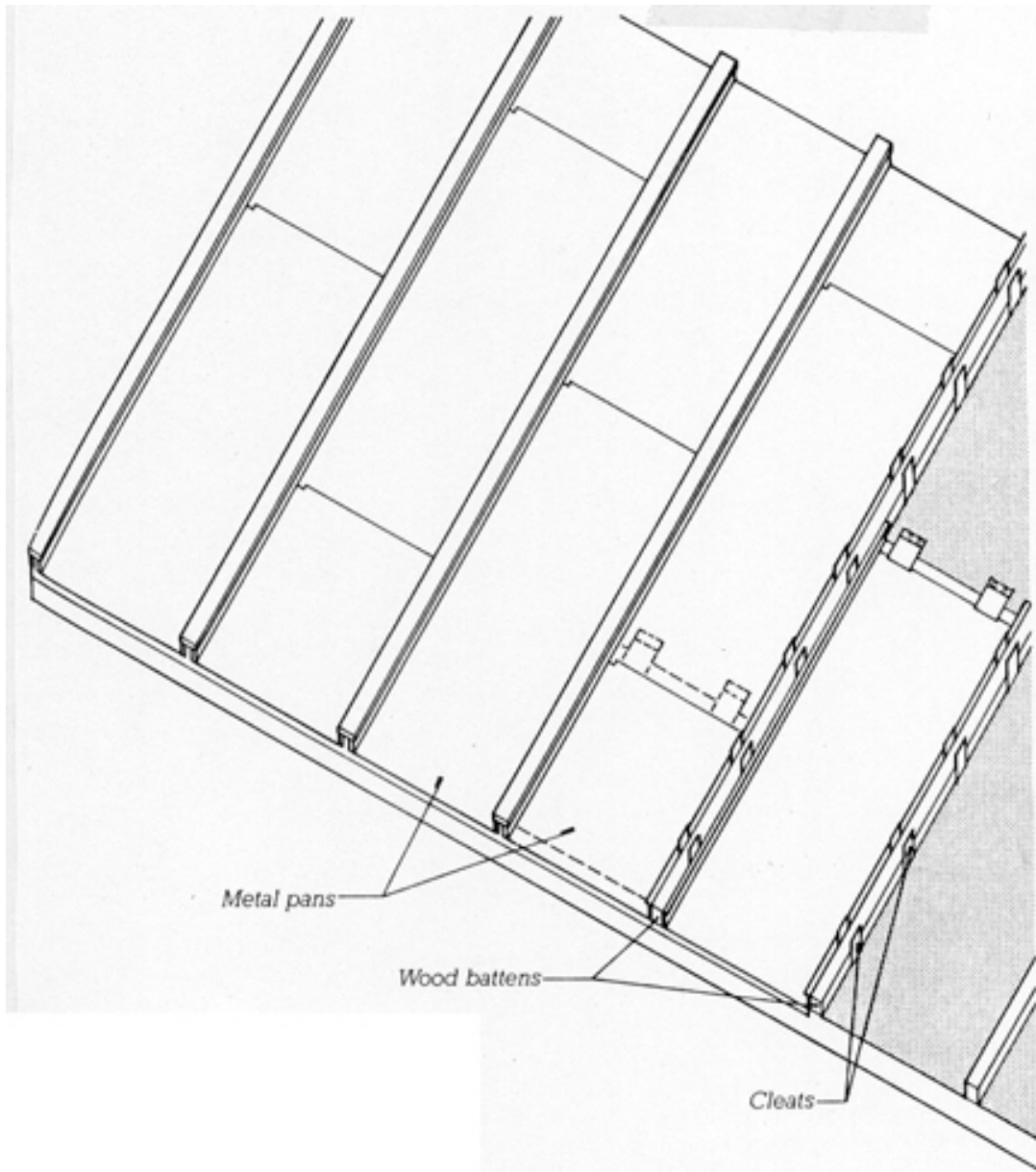
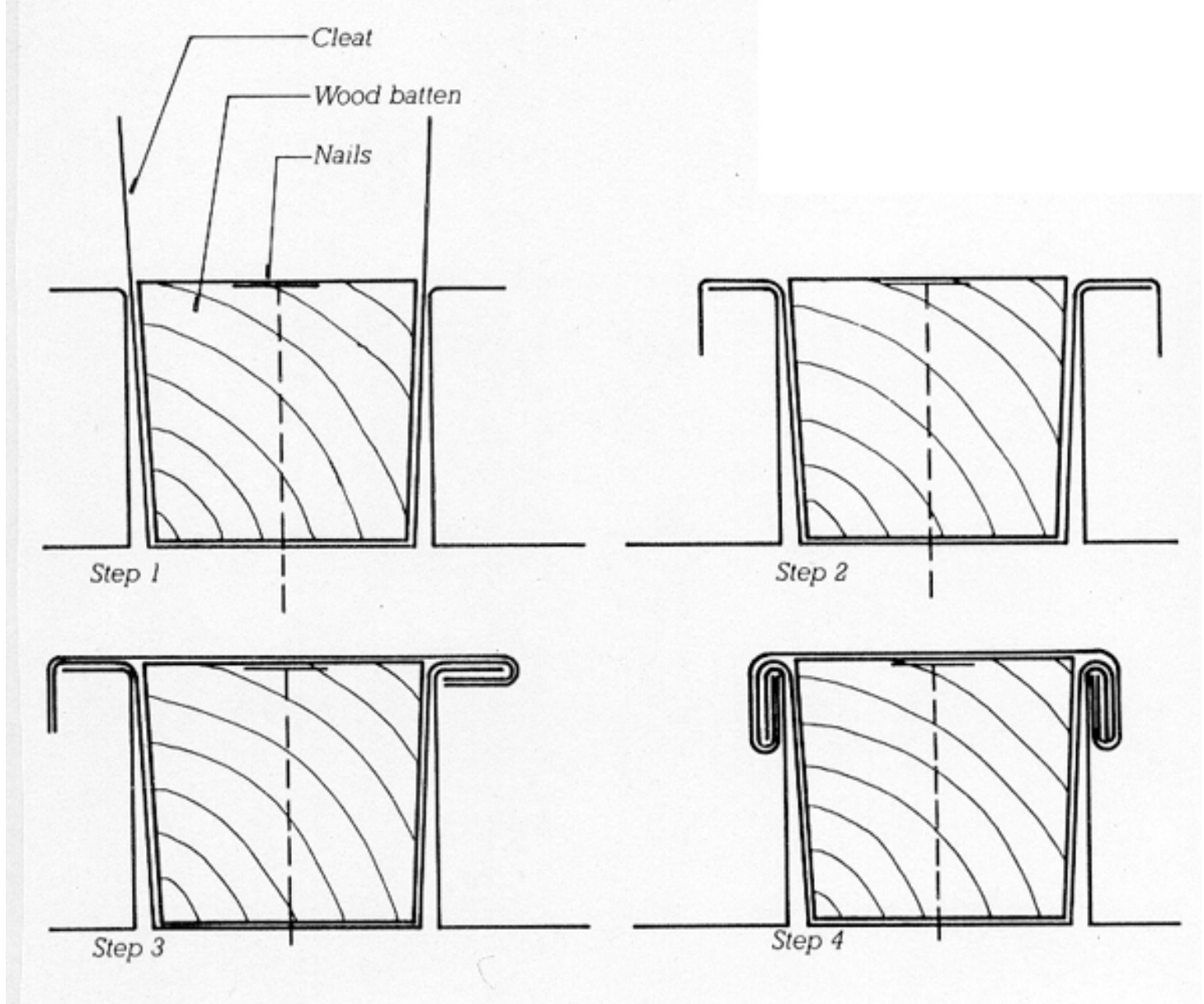

FIGURE 13.52

Installing a batten-seam metal roof. The battens are tapered in cross section to allow for expansion of the roofing metal.

Aluminum
Zinc and galvanized steel
Chromium
Steel
Stainless steel
Cadmium
Nickel
Tin
Lead
Brass
Bronze
Copper

Metal Roof: Blocked Seam



Metal Roof: Block Seam

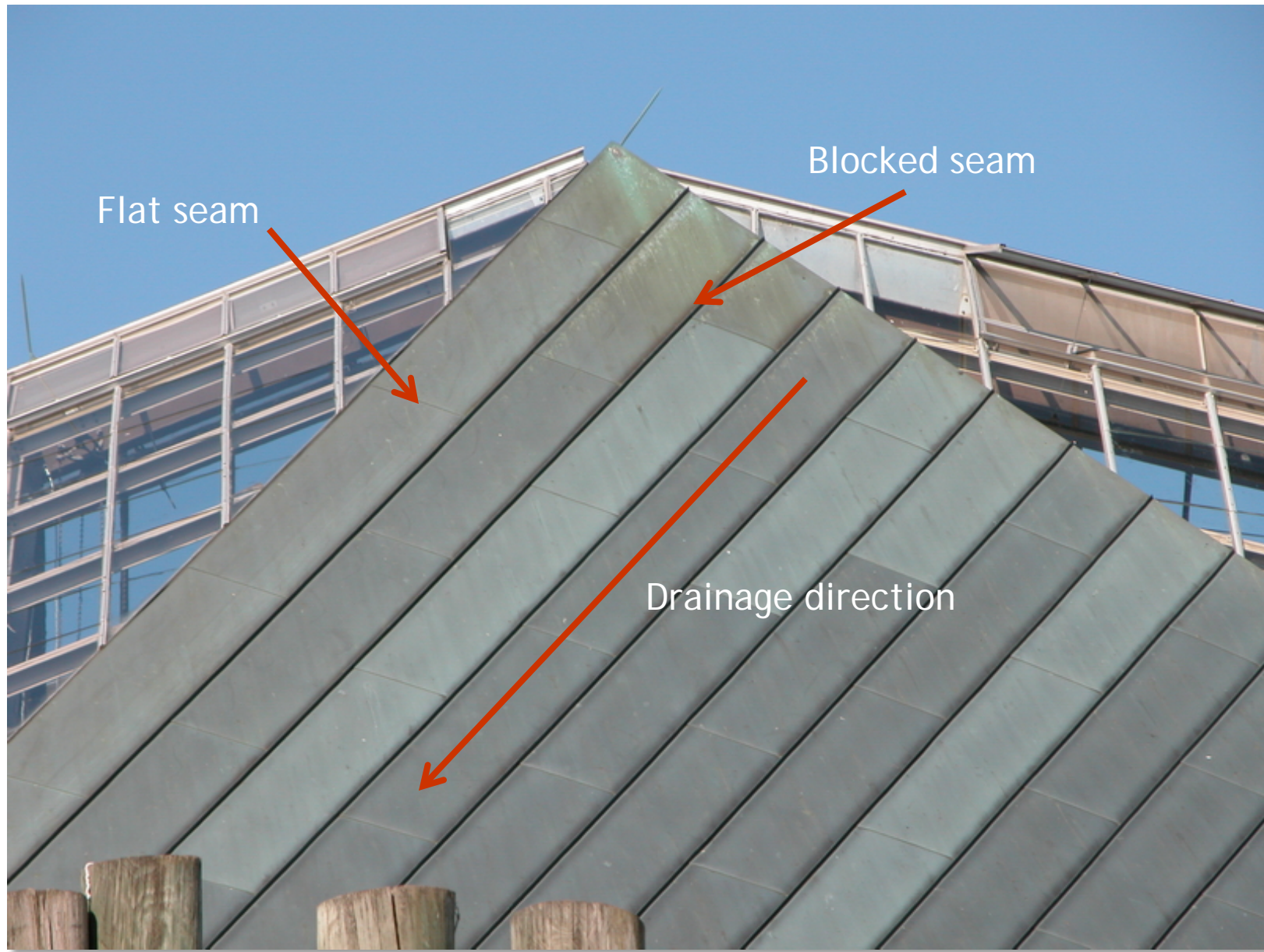

Toronto Zoo

3.

-  Insulation
-  Roof Sheet
-  Structural Roof Support
-  Air/Vapour Barrier
-  Thermal Barrier
-  Thermal Clip

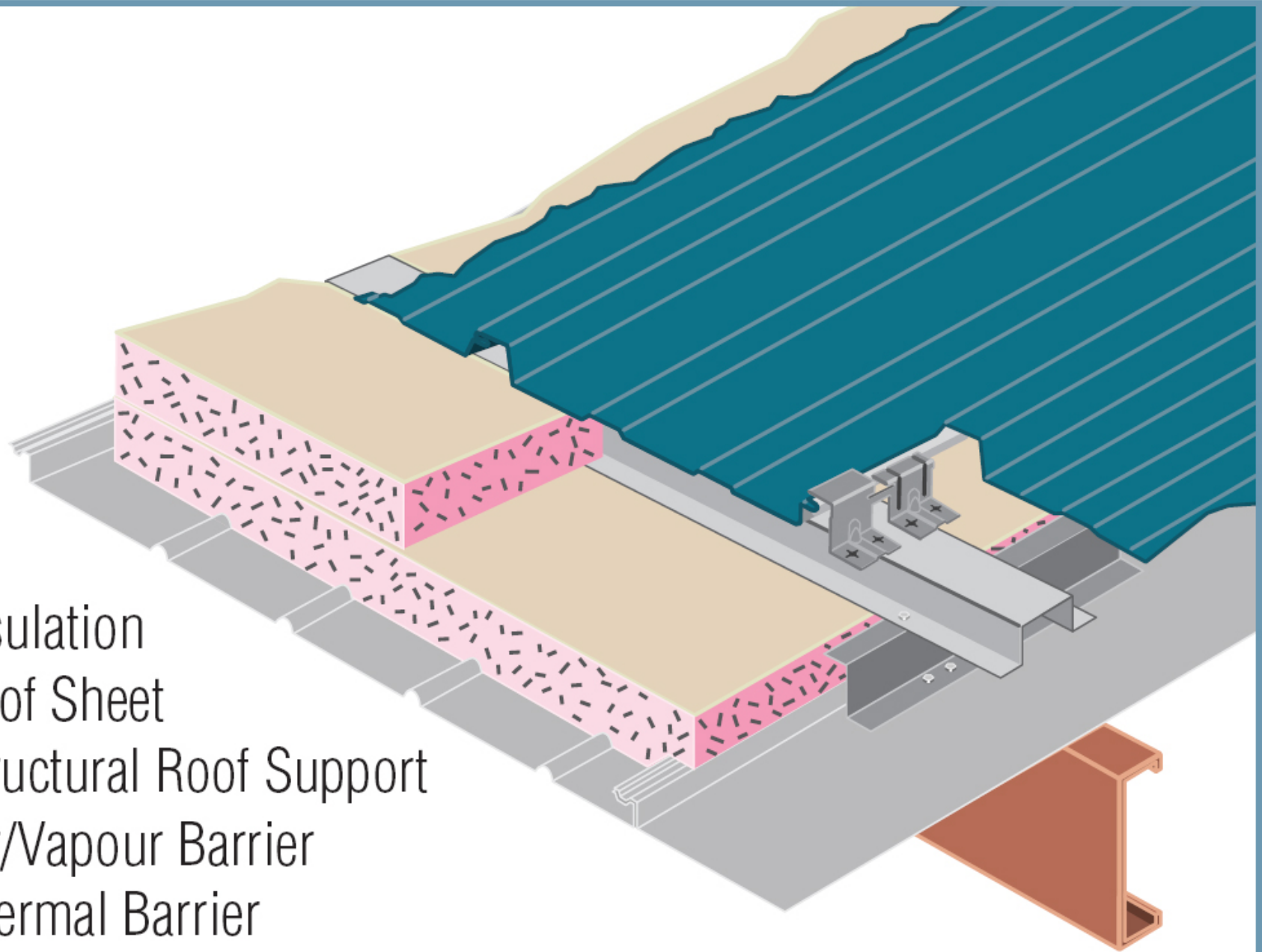

4.

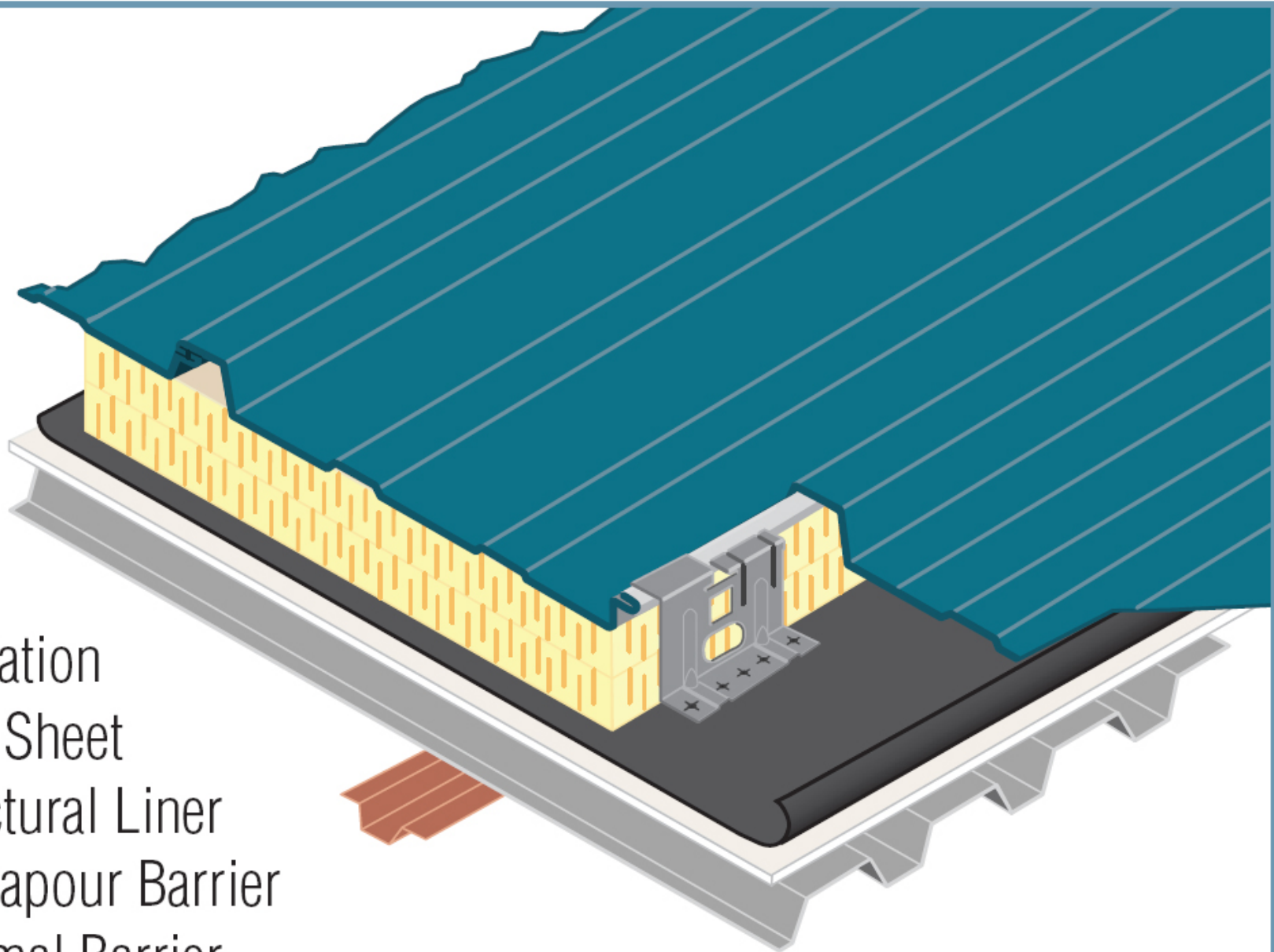

Insulation



Roof Sheet



Structural Liner



Air/Vapour Barrier



Thermal Barrier



Structural Roof Support



Thermal Clip



This is a metal roof with a snow dam at the edge. This is required to stop snow from sliding off the roof and on to the people below.



Snow guards at the edge of roofs



HOME DEPOT

 ONTARIO'S HOME IMPROVEMENT

able

kitchens

Blinds

APPLY



TODAY!



HARVEY'S

YOU FIND

WI

Flat or Low Slope Roofs:

PRIMARY COMPONENTS:

- structural roof deck
- thermal insulation
- vapour retarder (and air barrier)
- waterproof membrane



Structural Roof Deck:

- must be designed to *minimize deflection* to reduce ponding and minimize drainage
- either **slope the roof deck** or **taper the insulation** to drain roof
- usual materials are:
 - plywood
 - wood decking
 - cast or hollow core concrete
 - steel decking(choice depends on building type, fire rating and primary structural system)

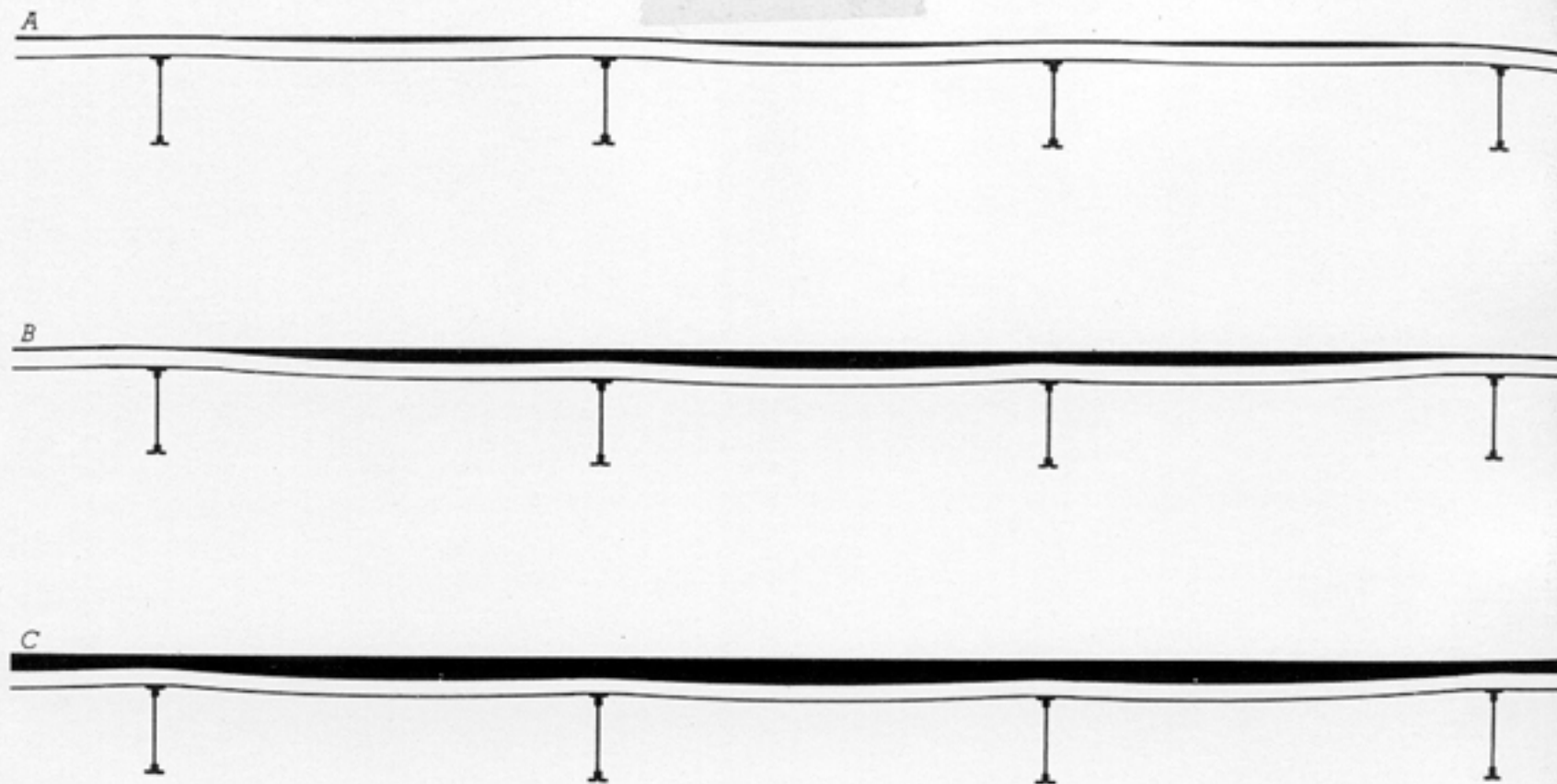

FIGURE 13.3

A low-slope roof with insufficient pitch to drain is subject to structural failure through progressive collapse, as demonstrated in this sequence of cross sections: (a) Water stands on the roof in puddles, causing slight deflections of the roof deck between supporting beams or joists. (b) If heavy rainfall continues, the puddles grow and join, and the accumulating

weight of the water begins to cause serious deflections in the supporting structural elements. The deflections encourage water from a broader area of the roof to run into the puddle. (c) As structural deflections increase, the depth of the puddle increases more and more rapidly, until the overloaded structure collapses.



Roof collapse in Poland due to excessive snow loading

Vapour Retarders for Low Slope Roofs:

- membrane in a protected membrane roof is also the vapour/air barrier
- other types of low slope roofs use two layers of asphalt saturated roofing felt bonded together and to the roof with hot asphalt
- polyethylene film not used as it melts
- situated on the warm side of the insulation

Thermal Insulation:

Can be installed in THREE positions:

- **BELOW** the deck (classic house attic scenario)
- **BETWEEN** the deck and the membrane
- **ABOVE** the membrane

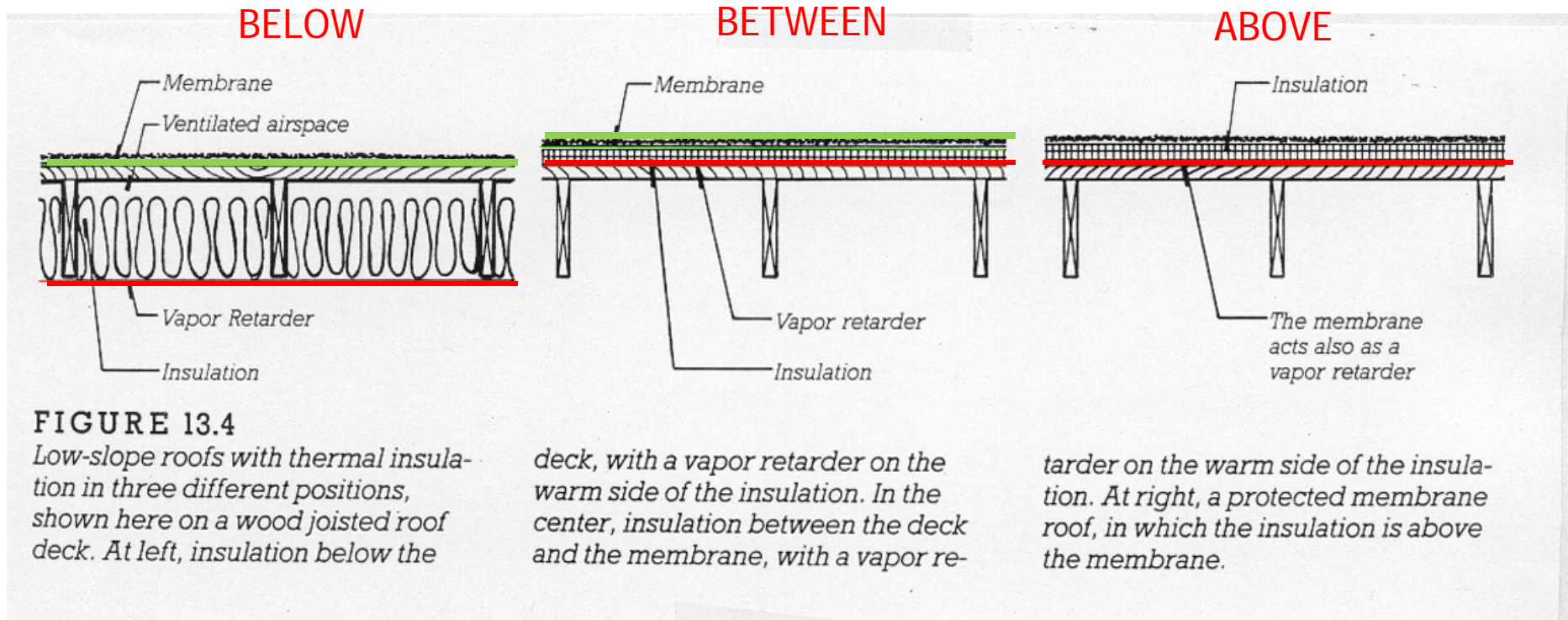

A vented air space is mandatory when using batt insulation in a flat roof!!

If you use rigid polystyrene insulation (the blue kind) or a foamed in place closed cell type, no air space is necessary as it is waterproof.

Flat Roof: Insulation and Membrane Position

BETWEEN

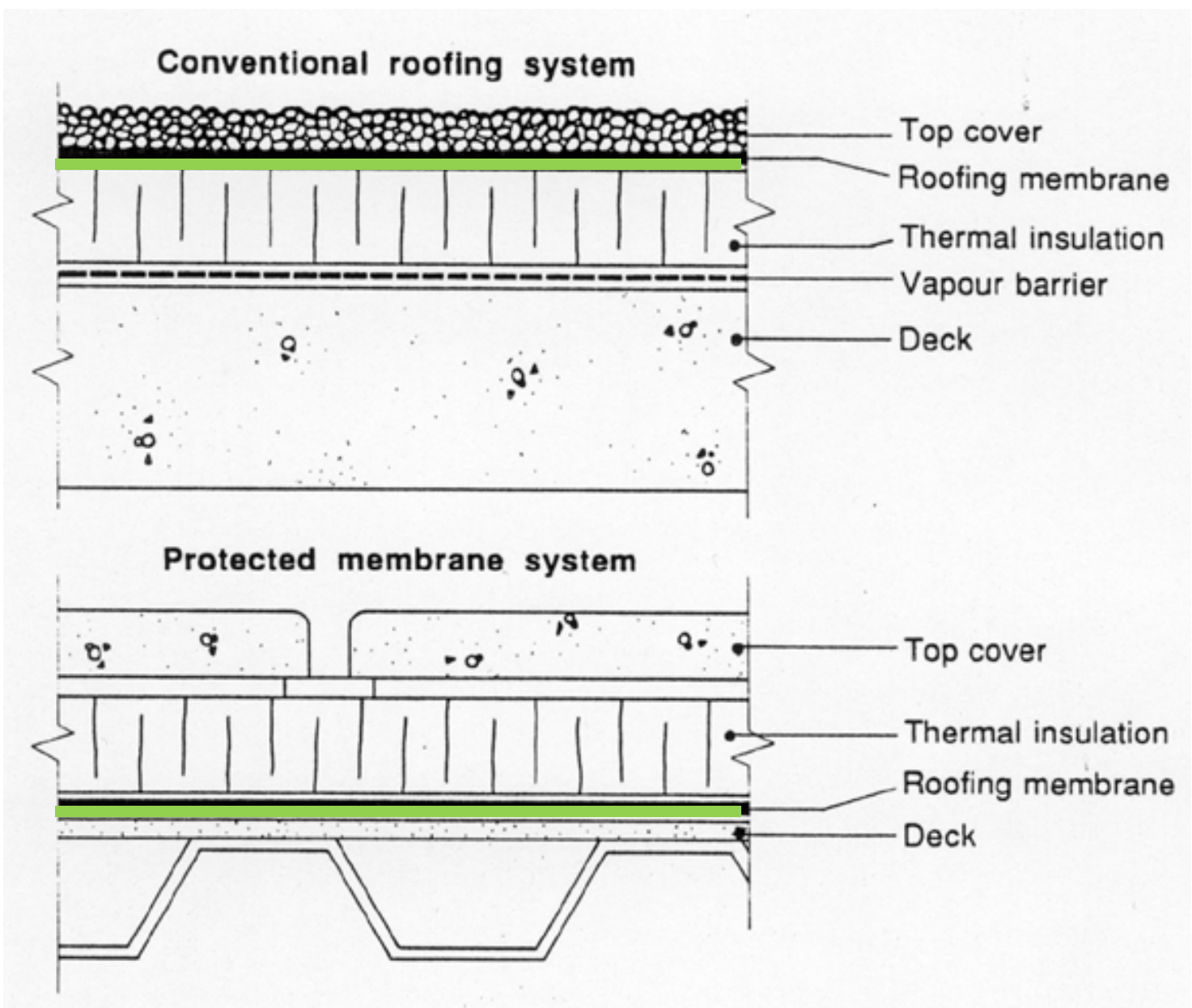

ABOVE

Flat Roof: BUR (traditional) vs. Inverted (newer methodology)

Insulation BETWEEN Membrane and Deck:

Traditional location for insulation:

- use low density rigid panels to support the loads on the roof membrane without allowing puncture of membrane
- any water vapour trapped in insulation will cause deck to rot so use topside vents to relieve pressure

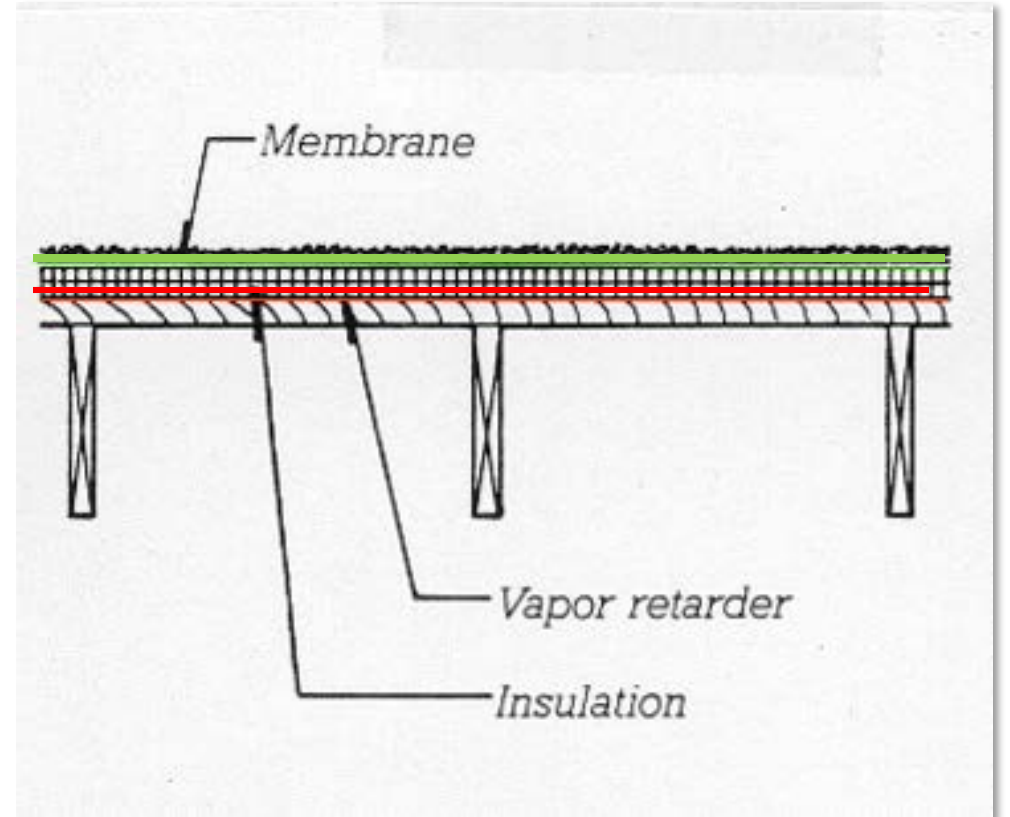

Insulation BETWEEN Membrane and Deck:

Extruded polystyrene insulation is used on roofs (often blue in colour) as it is not penetrable by water so cannot deteriorate due to water logging. It is sensitive to UV radiation so must be protected.

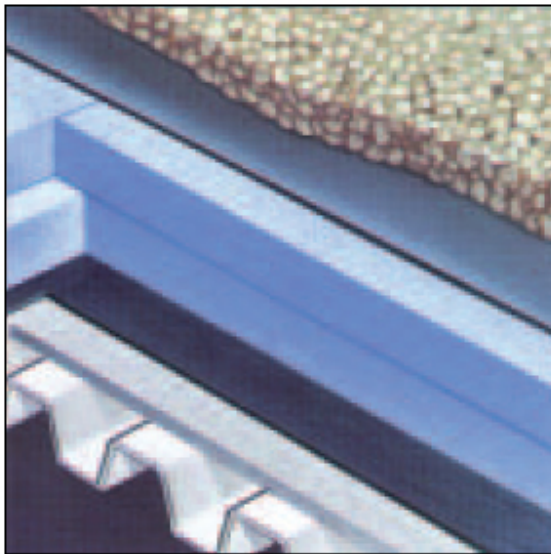

Loose Laid Ballasted
Single-Ply Membrane

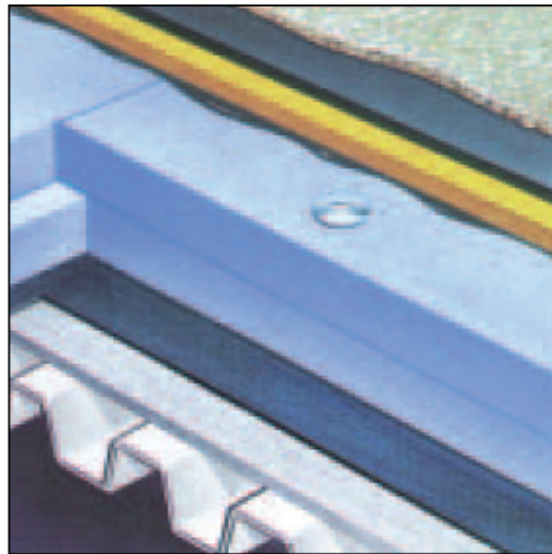

Fully Adhered
Single-Ply Membrane

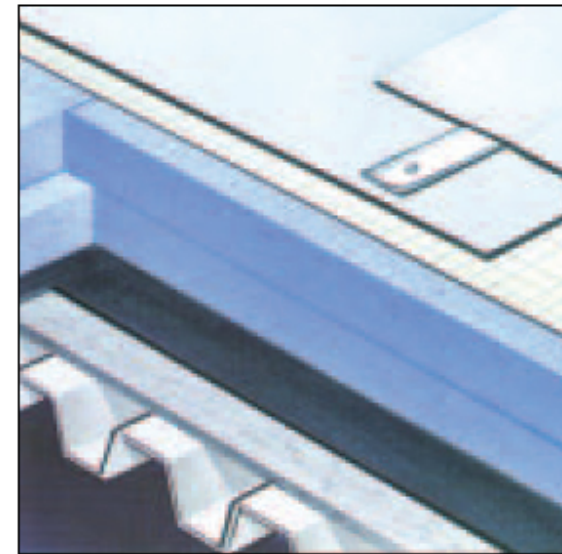

Mechanically Fastened
Single-Ply Membrane



Insulation ABOVE the Membrane:

- “New” concept (post 1970) offering major advantages:
- ✓ membrane protected from extremes of heat and cold, is on the warm side of the insulation
 - ✓ membrane protected from UV radiation
 - ✓ membrane protected from puncture
 - ✓ insulation must be extruded polystyrene (XPS) foam board which is water resistant and covered with a filter layer to prevent migration of ballast

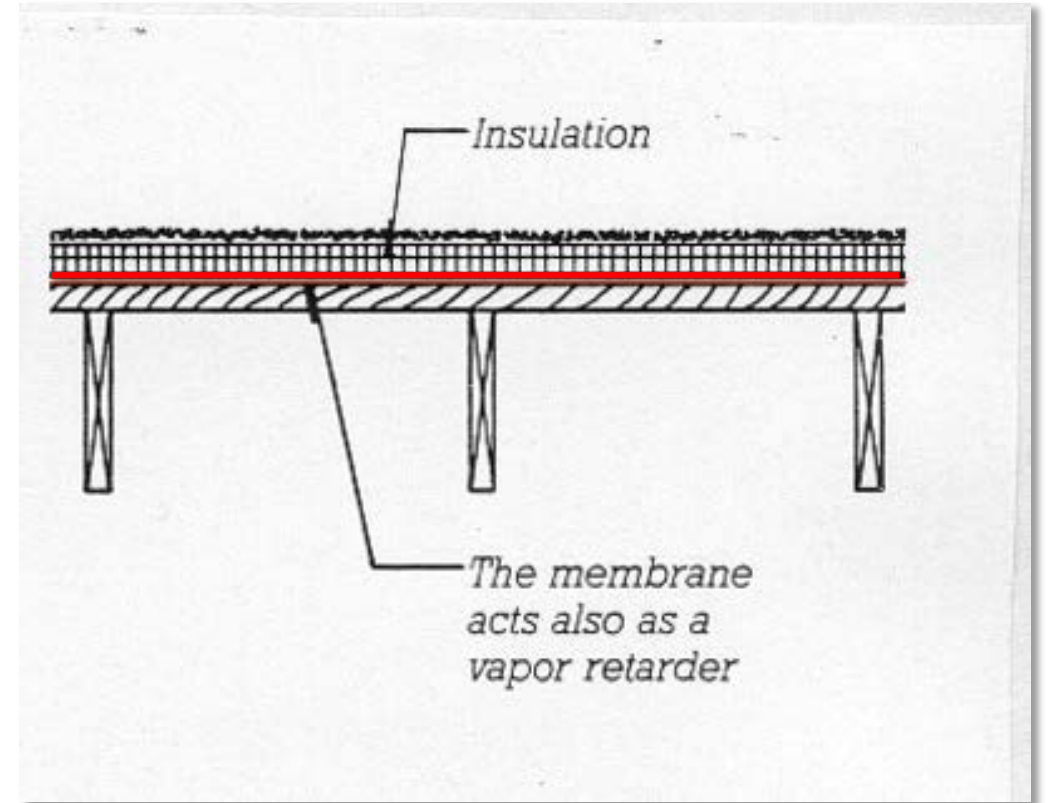

ROOFING MEMBRANES:

THREE PRIMARY TYPES:

- conventional (bituminous built up roofing or BUR)
- prefabricated sheets (single ply)
- cast in situ

Conventional: The Built Up Roof (BUR)

- constructed of 3 to 5 layers of bitumen impregnated felts, layered on the roof deck with heated asphalt
- may be located either over or under the rigid insulation
- top layer of gravel ballast to protect asphaltic materials or insulation from UV rays, and to weight roofing materials against wind uplift forces

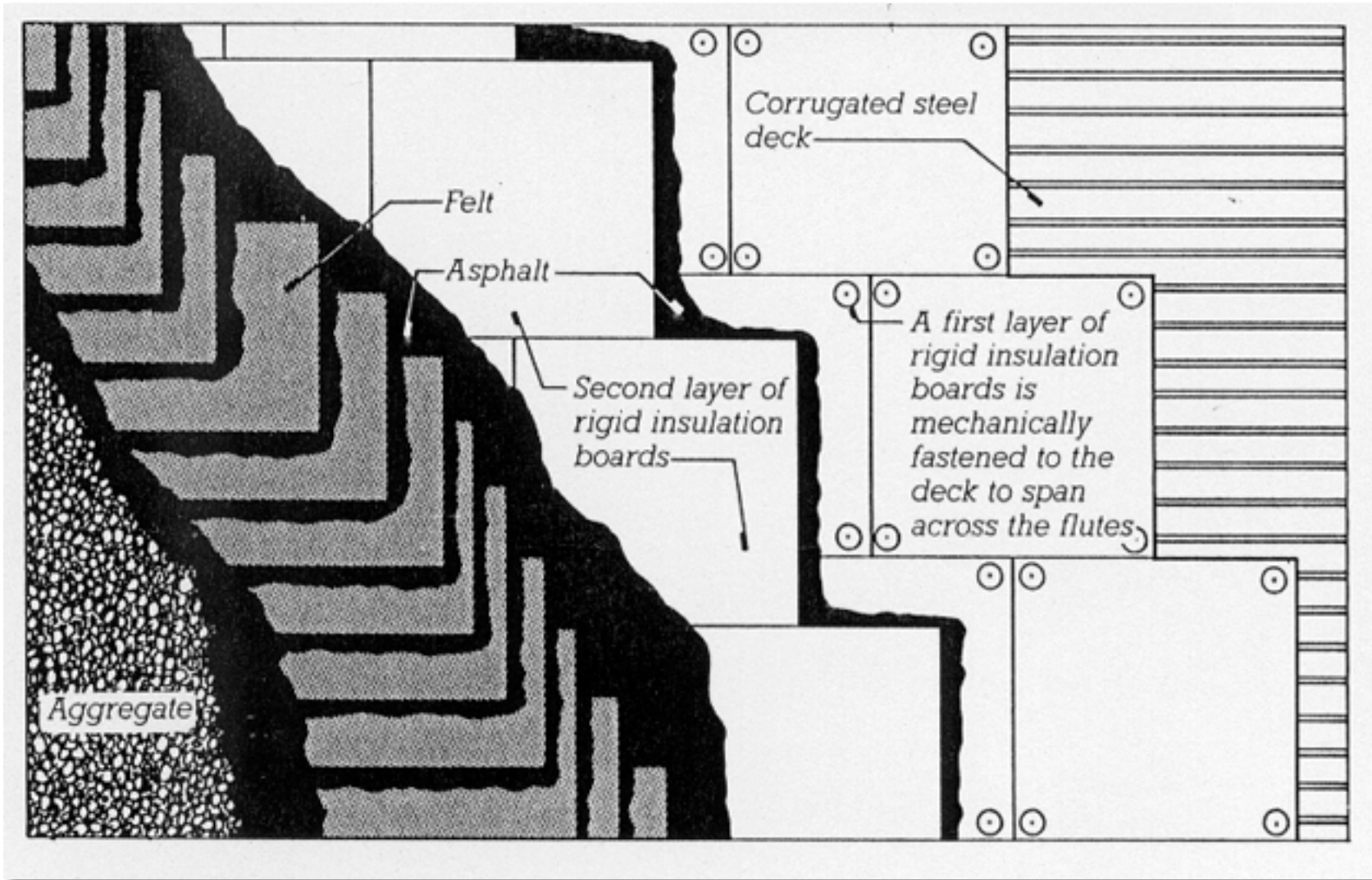

BUR on steel decking: insulation below the membrane

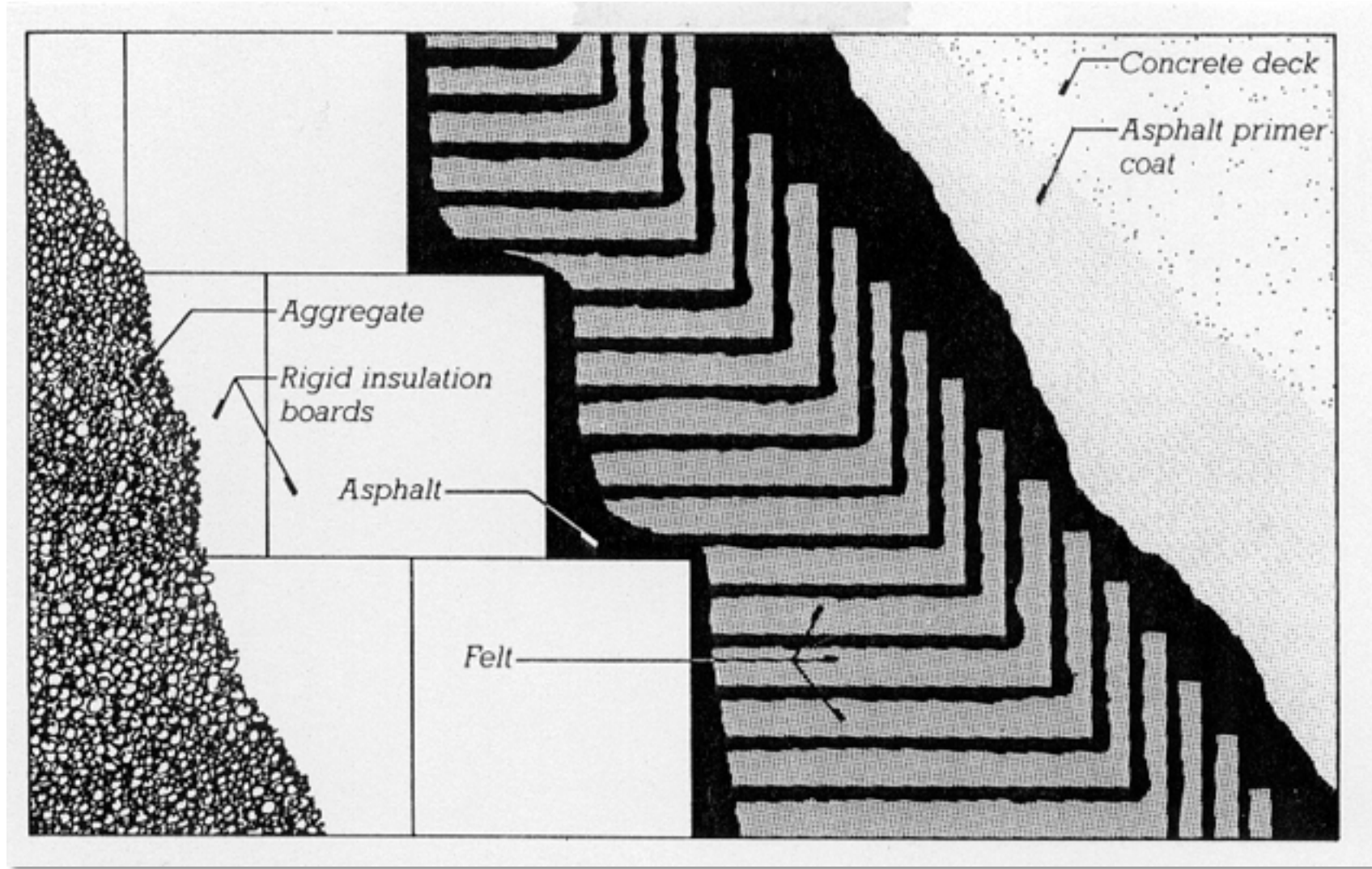

BUR on concrete roof deck: insulation above the membrane

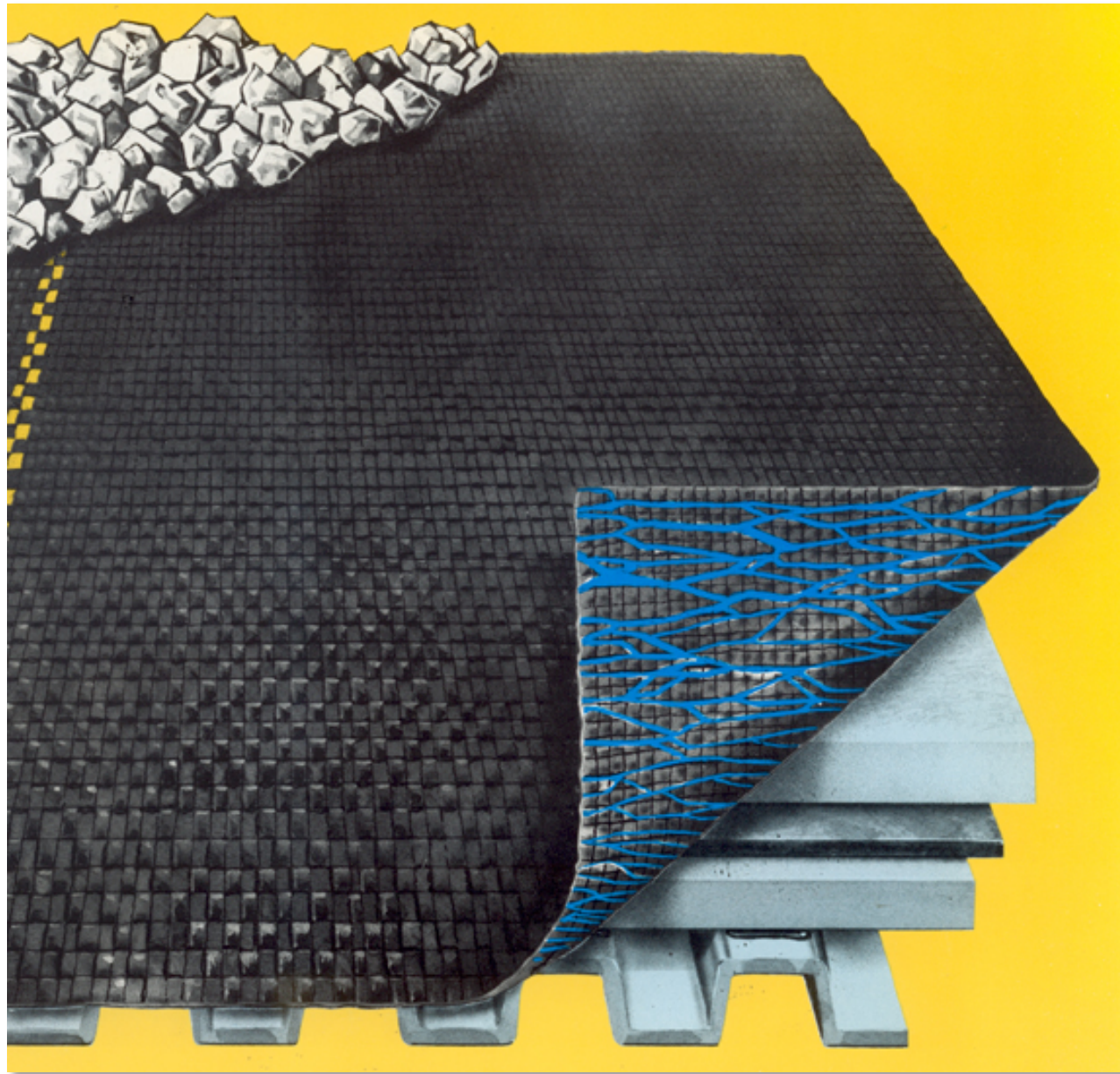

Flat Roof: fibre matt used to keep ballast away from insulation



Built up Roof
(BUR)



Built up Roof (BUR)



Prefabricated Sheets: Single Ply

THERMOPLASTIC SHEETS:

- PVC and blends
- EP (ethylene interpolymers)
- CPA (copolymer alloys)

ELASTOMERIC (SYNTHETIC) RUBBER SHEETS:

- vulcanized, EPDM or neoprene
- non vulcanized

MODIFIED bituminous SHEETS:

- polymer modifiers

PREFABRICATED SHEETS: Installation and Attachment

- require less on site labour
- less prone to cracking
- affixed to roof by:
 - adhesives
 - the weight of ballast
 - fasteners concealed in seams between the sheets
 - with ingenious mechanical fasteners that do not penetrate the membrane (if it is flexible enough...)

THERMOPLASTIC SHEETS:

PVC:

- commonly known as vinyl
- seams are sealed either by solvent welding or hot air welding
- may be laid loose, mechanically attached, adhered or used as a protected membrane
- This material is not very good for the environment (red list material)

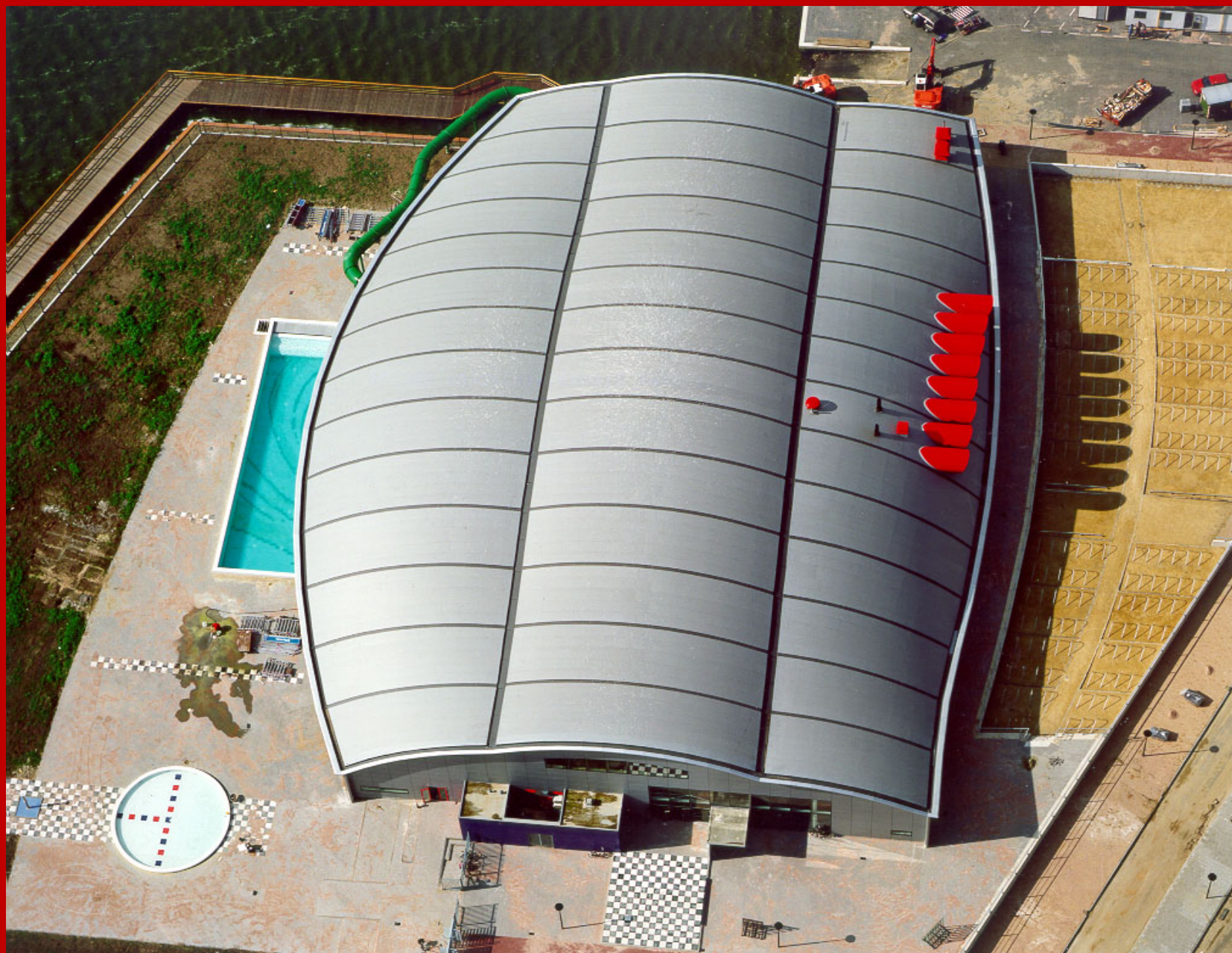



PVC Roof at Pearson International Airport

ELASTOMERIC (SYNTHETIC) RUBBER SHEETS:

Neoprene

- high performance synthetic rubber compound
- applied in sheets and joined with an adhesive
- vulnerable to UV rays so coated with a protective layer
- may be adhered, mechanically fastened or laid loose and ballasted
- can be used in a protected membrane roof

ELASTOMERIC (SYNTHETIC) RUBBER SHEETS: EPDM (ethylene propylene diene monomer):

- the most widely used material for single ply roofs
- low in cost
- synthetic rubber made in large sheets
- joined with adhesive, laid loose, adhered, mechanically fastened or used in a protected membrane roof



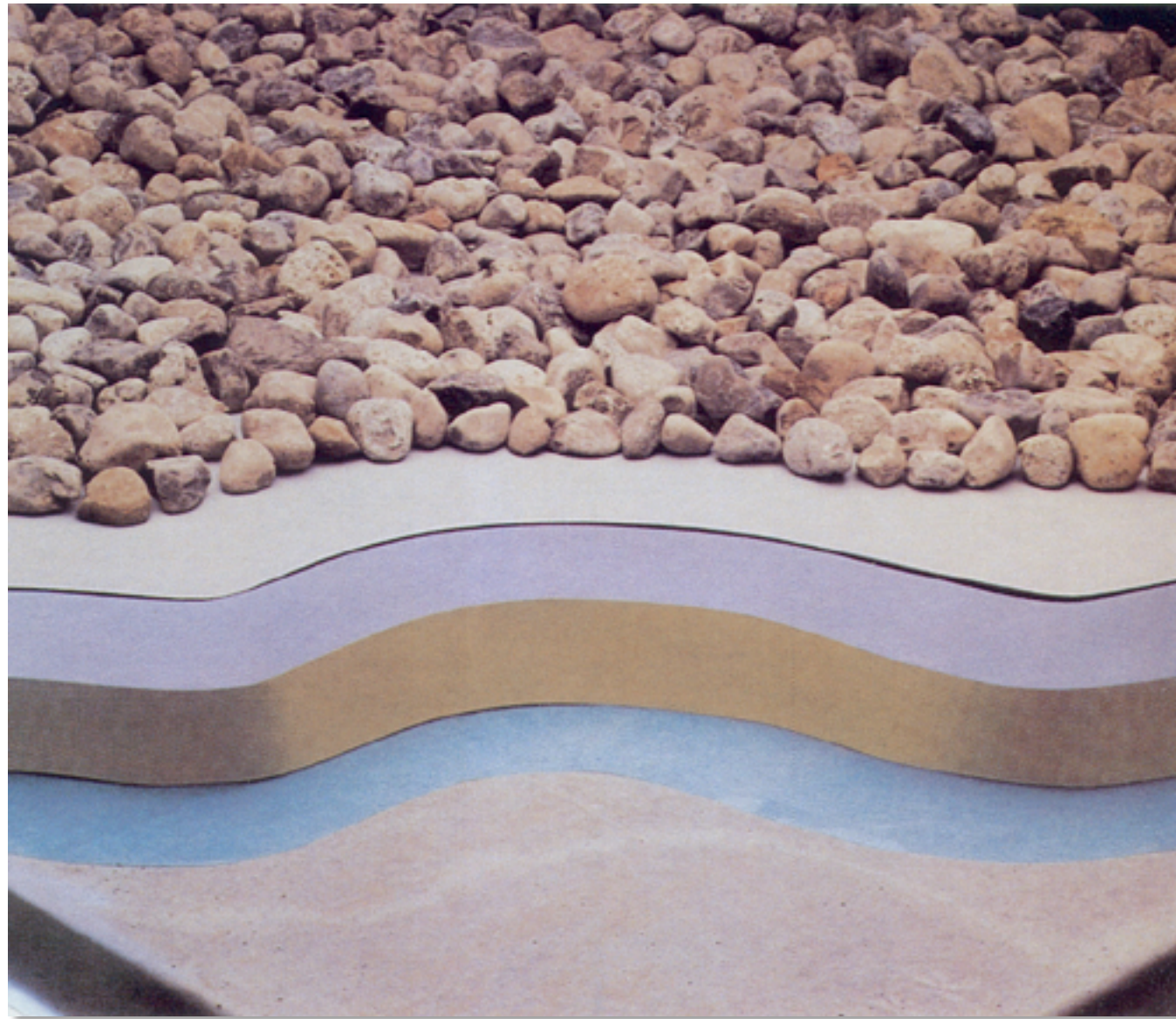

Loose laid, ballasted, membrane

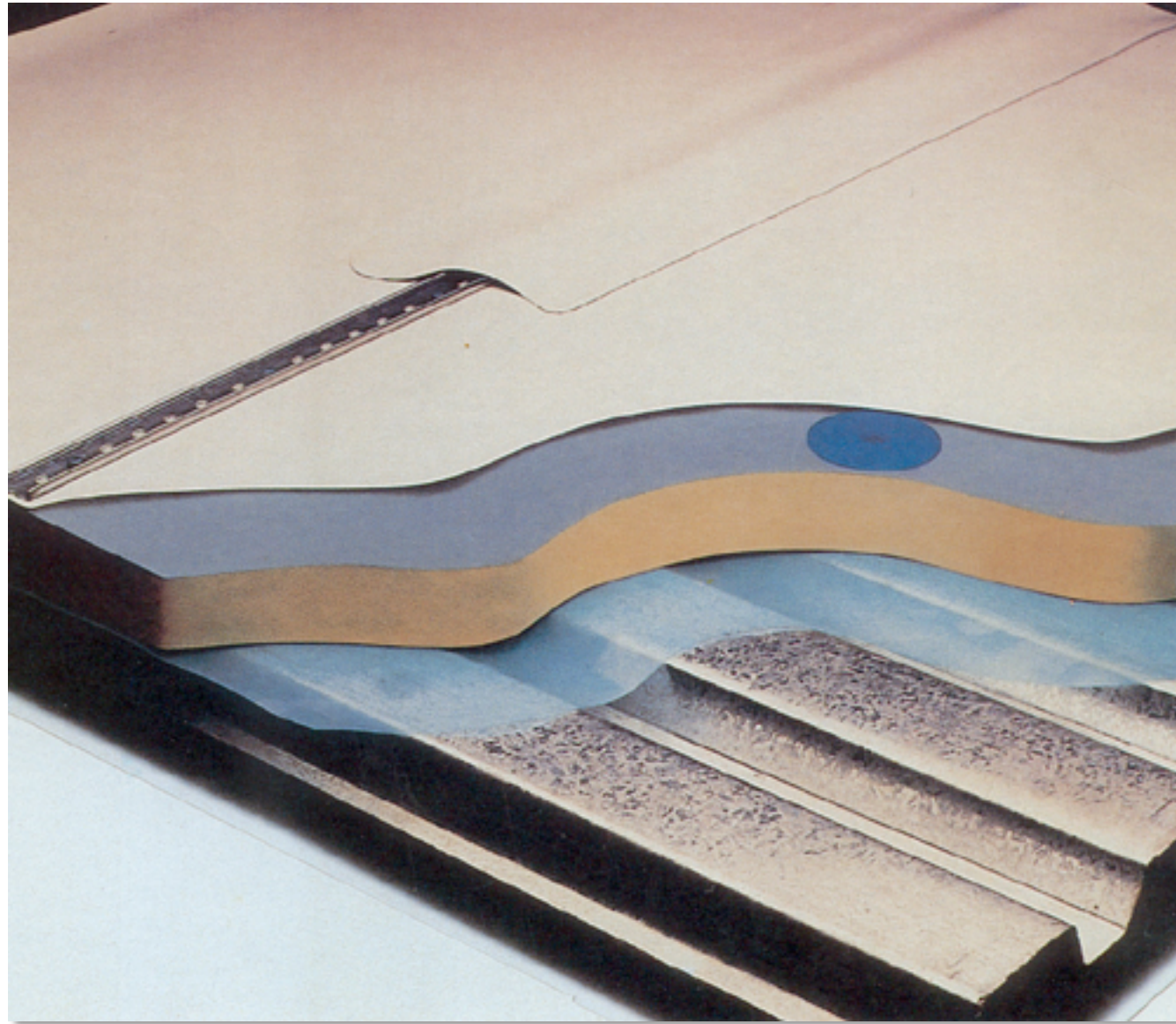

Mechanically fastened membrane: bar type

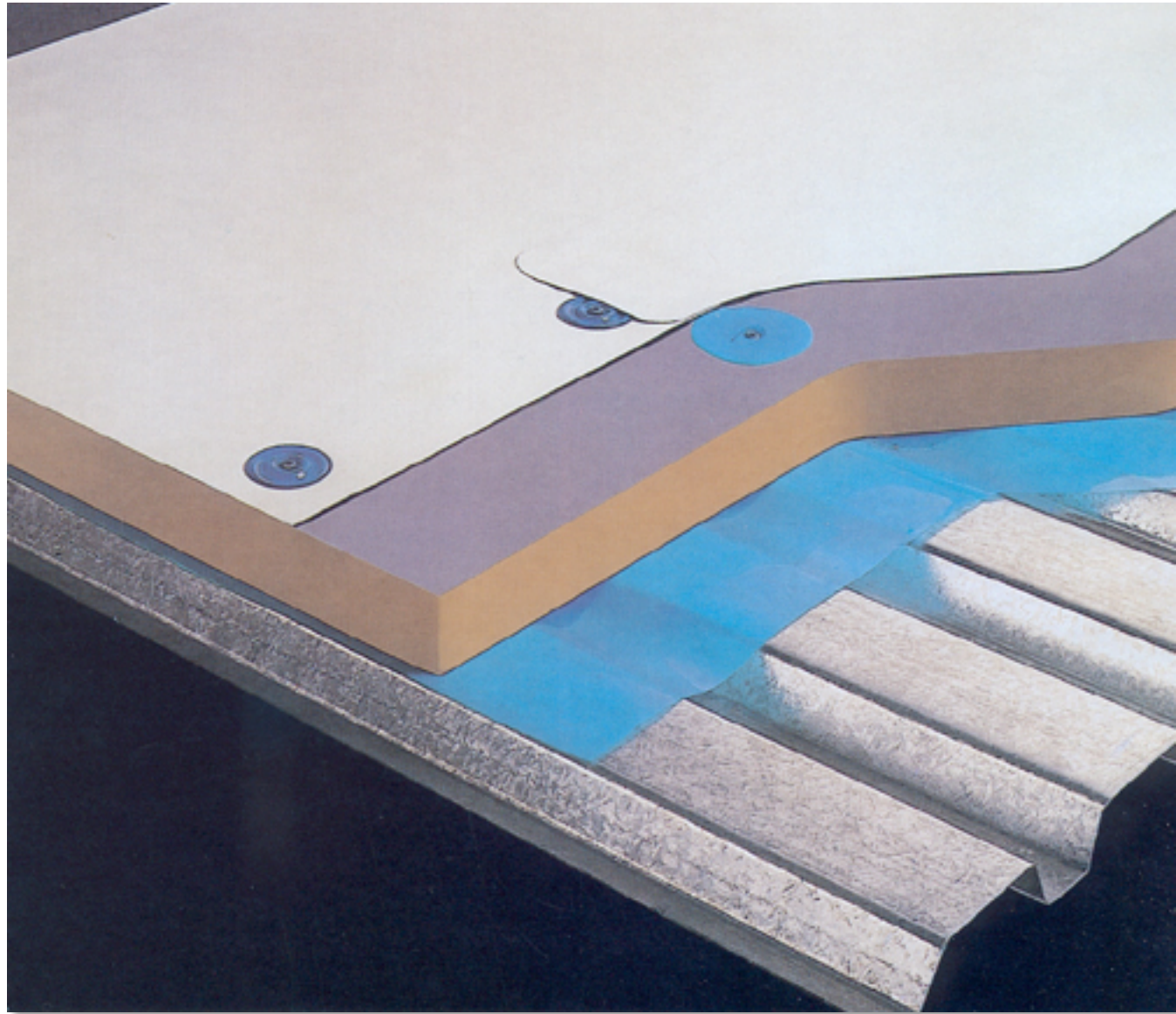

Mechanically fastened with disc fasteners

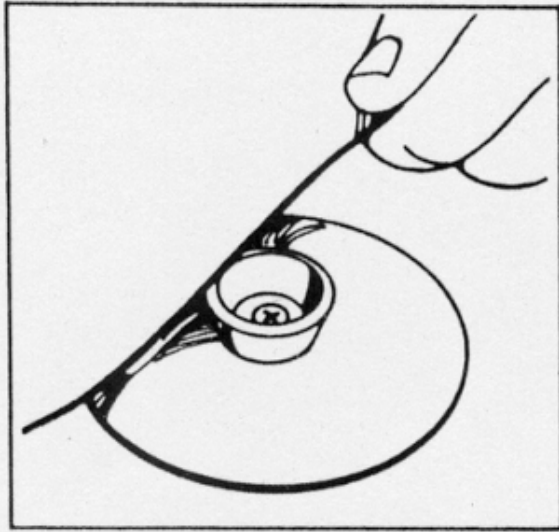

1. Roll membrane over knobbed base plate

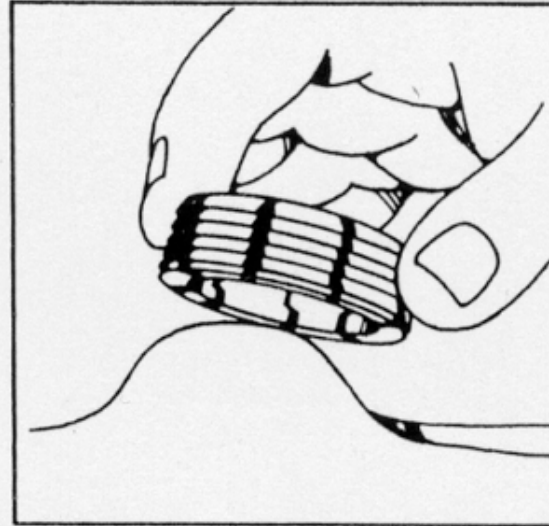

2. Roll and snap on white retainer clip

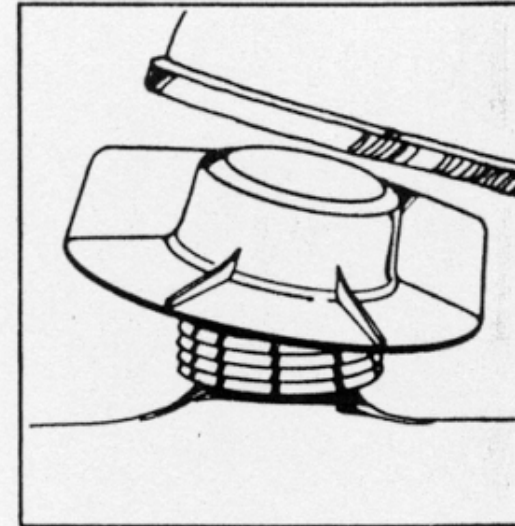

3. Snap and screw on threaded black cap

Disc fastener detail

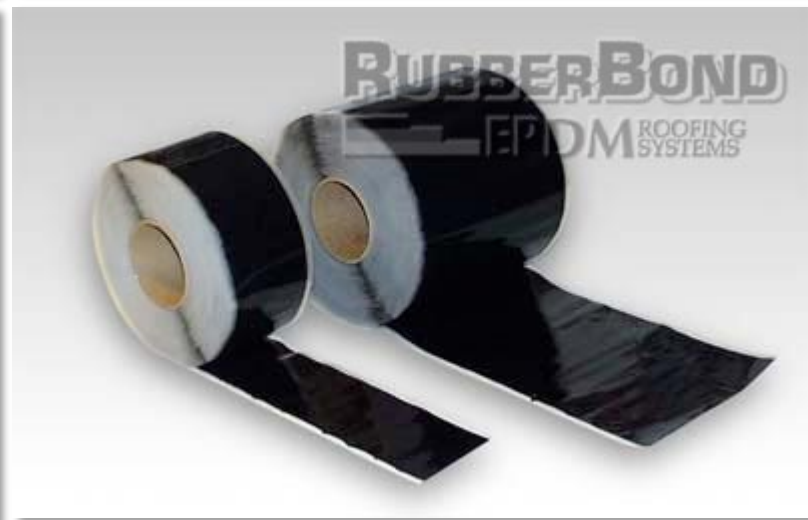
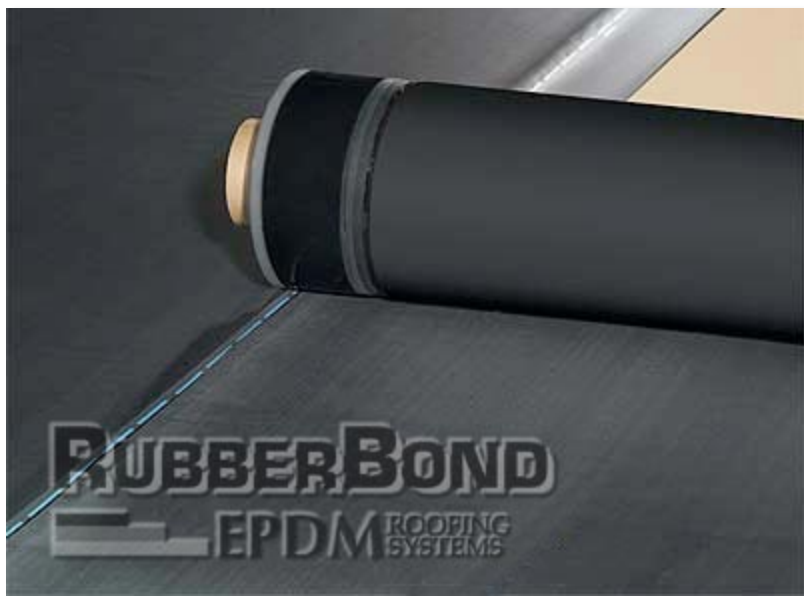



EPDM flashing

EPDM - loose laid and ballasted



Mechanical fastening strips and an EPDM roof





Polymer Modified Bitumens:

- sheets of bituminous material to which polymeric compounds have been added to increase cohesion, toughness and resistance to flow
- reinforced with fibrous mats
- some self adhere, or loose laid or laid in hot asphalt
- seams sealed by torching or hot asphaltic adhesive





Rolls of
polymer
modified
bituminous
roofing
sheets



OCAD modified bitumenous membrane roofing ready for installation





This is the roofing membrane being installed on the top of the new OCAD addition.



This is a multi-ply installation. The black being the base layer and the grey the more durable top layer. The insulation is beneath the black layer.



Detail at parapet. Note water overflow opening.

Can you spot the overflow
opening??



There is the
overflow spout!



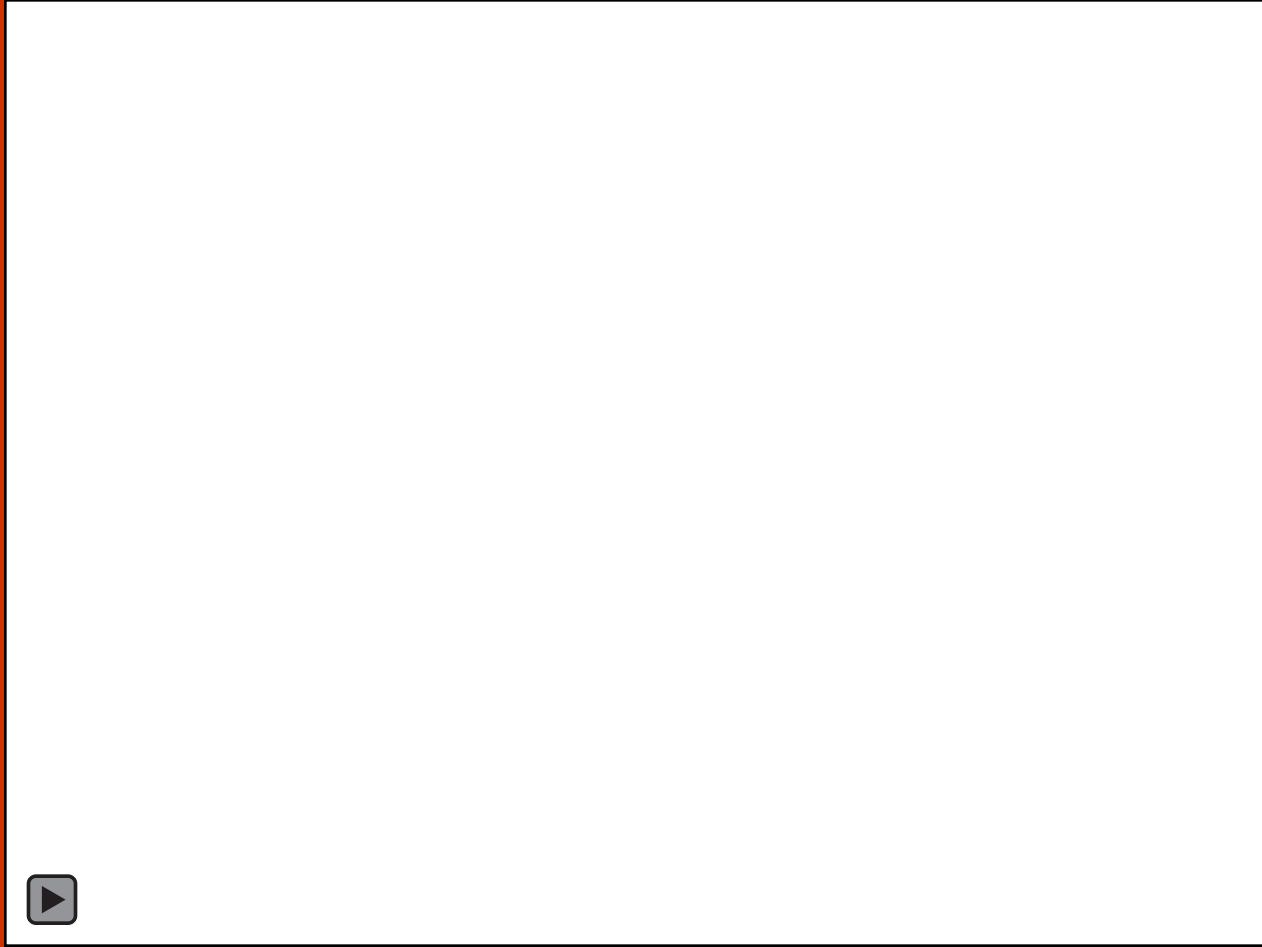

Cast in Situ Membranes:

HOT APPLIED RUBBERIZED ASPHALT

COLD APPLIED LIQUID COMPOUNDS

- various polymeric and bituminous materials

POLYURETHANE FOAM ROOF WITH PROTECTIVE
COATING

Fluid Applied Membranes:

- used primarily for domes, vaults and complex shapes
- applied with a roller or spray gun in several coats and cure to form a rubbery membrane
- used as a spray on waterproofing layer over sprayed on polyurethane foam insulation



Spray applied elastomeric membrane roofing



Spray applied elastomeric membrane roofing

REQUIREMENTS OF ROOFING MEMBRANES:

- tensile strength
- elongation
- crack bridging
- fatigue resistance
- thermal shock
- tear resistance
- abrasion resistance
- lap joint integrity
- static puncture
- impact resistance
- low temp. flexibility
- weatherability
- heat aging
- dimensional stability
- granule embedment

Requirements continued:

- membrane attachment
- flashing attachment
- materials compatibility
- wind uplift resistance

These requirements apply to conditions during manufacture, during installation and in the field in service.

Details

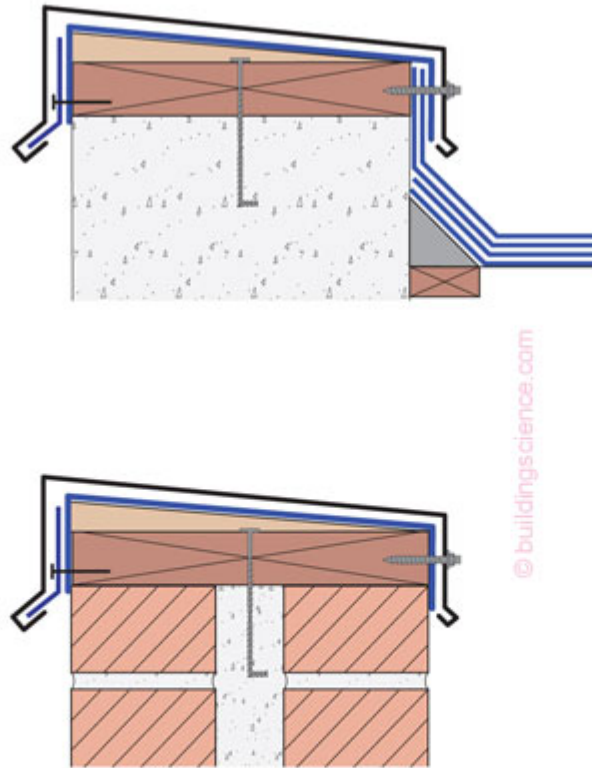

*Adapted from Baker, M.; Roofs, 1980;
Courtesy National Research Council of Canada*

Figure 4: Parapet Water Management—Keep rainwater from getting into the top of them. Slope the top of them inward so they don't stain the building façade. Make sure there is a waterproof membrane under the coping. And always have drip edges—front and back—so they don't stain the building façade.

<https://www.buildingscience.com/documents/insights/bsi-050-parapets-where-roofs-meet-walls>

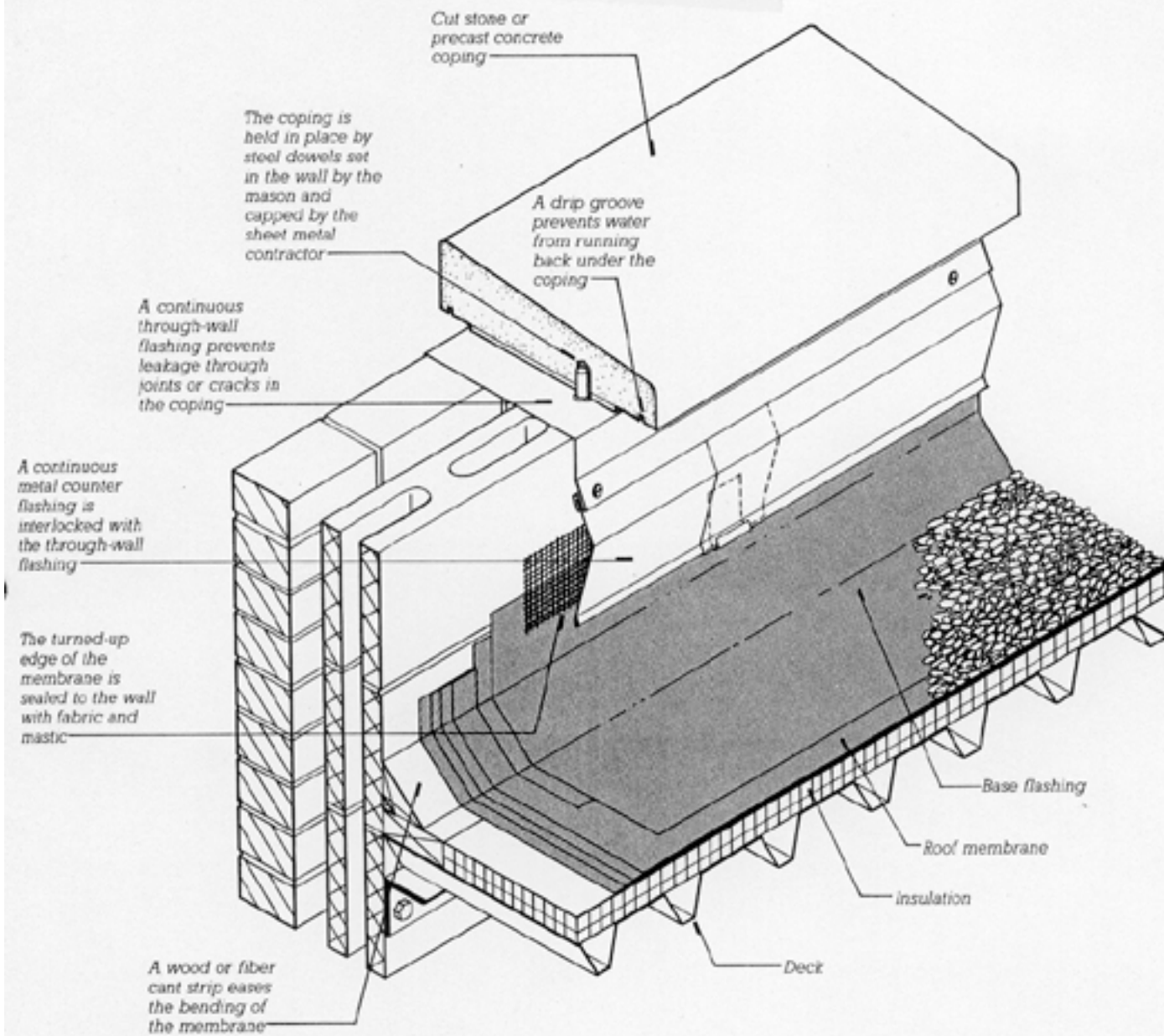

FIGURE 13.29
A conventional parapet design. The coping attachment and flashing are very labor intensive, and therefore costly.

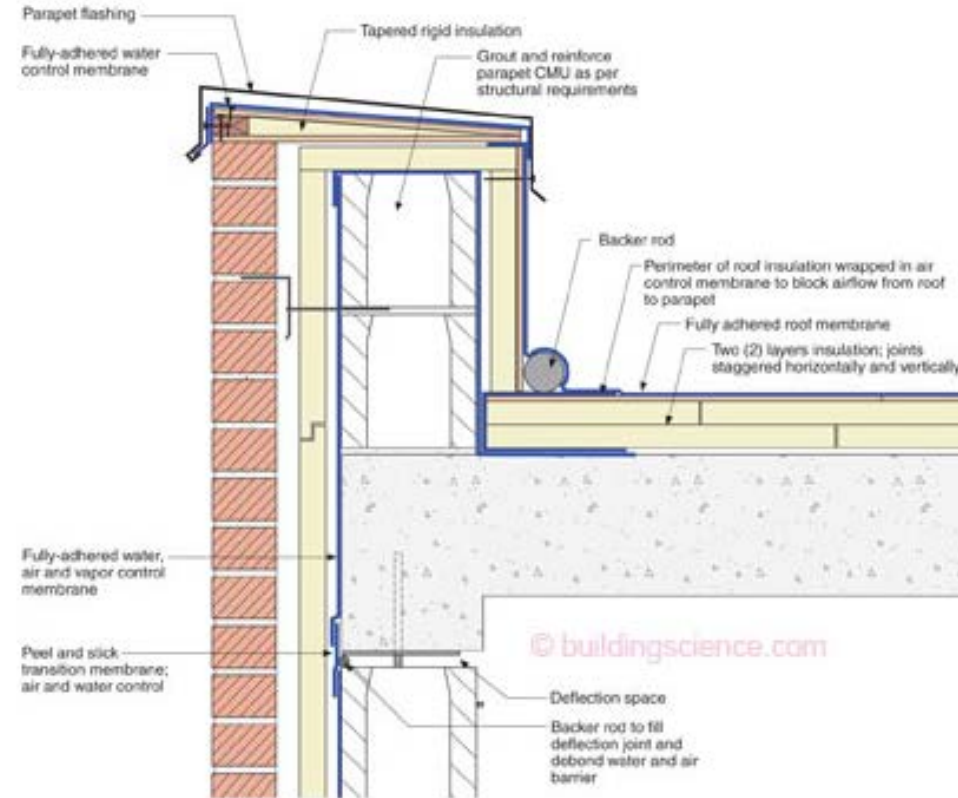

Figure 13: The Masonry Parapet—The thing to note here is that the concrete deck is the air control layer so an additional one is not necessary. However, joints in the concrete deck need to be addressed for air control layer continuity.

<https://www.buildingscience.com/documents/insights/bsi-050-parapets-where-roofs-meet-walls>

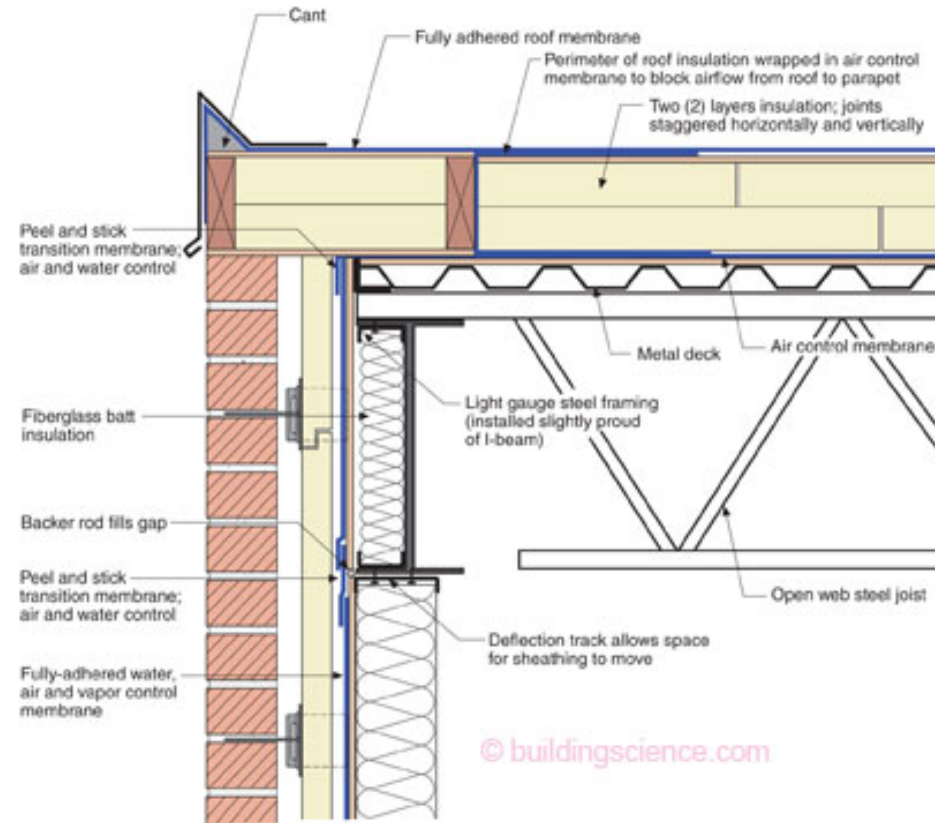

Figure 15: The Cantilevered Mini Parapet—Notice that air control layer continuity is achieved by wrapping the membrane over the building corner and then constructing the cantilevered portion of the parapet over the top of this air seal.

<https://www.buildingscience.com/documents/insights/bsi-050-parapets-where-roofs-meet-walls>

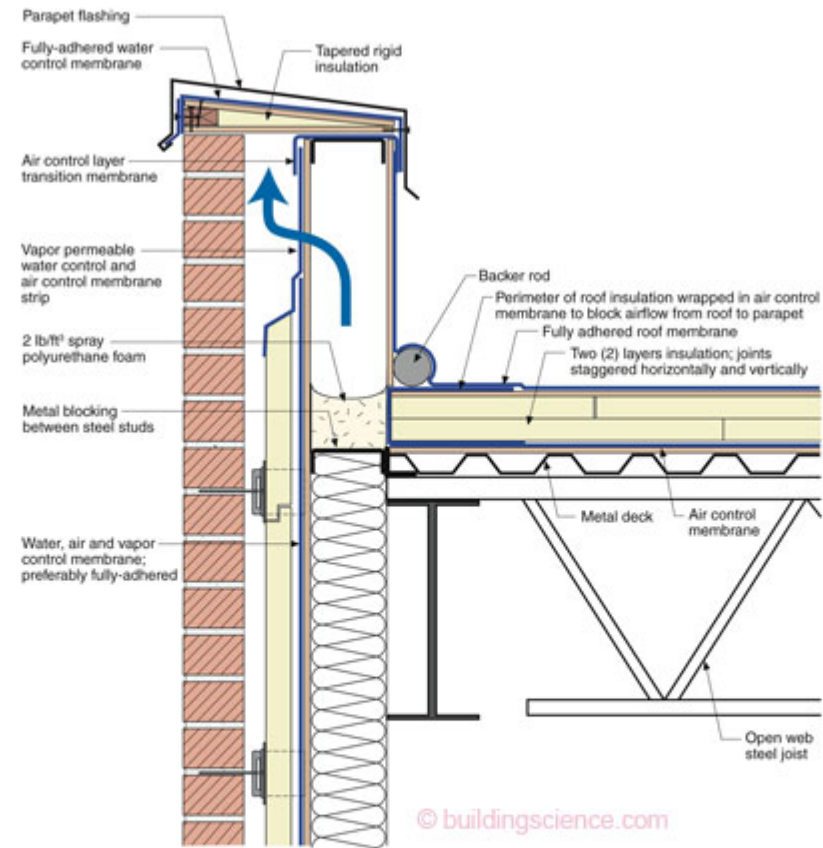

Figure 14: The Balloon Framed Steel Stud Parapet— This is the ugliest parapet to get right. Notice the use of spray polyurethane foam, the high density stuff, to provide air control layer continuity across the balloon framed exterior steel stud wall. The spray foam is supported by horizontal bridging or metal blocking. This is a tricky thing to execute and, as such, we design into the upper parapet assembly a pathway for drying via diffusion to provide some performance redundancy.

<https://www.buildingscience.com/documents/insights/bsi-050-parapets-where-roofs-meet-walls>

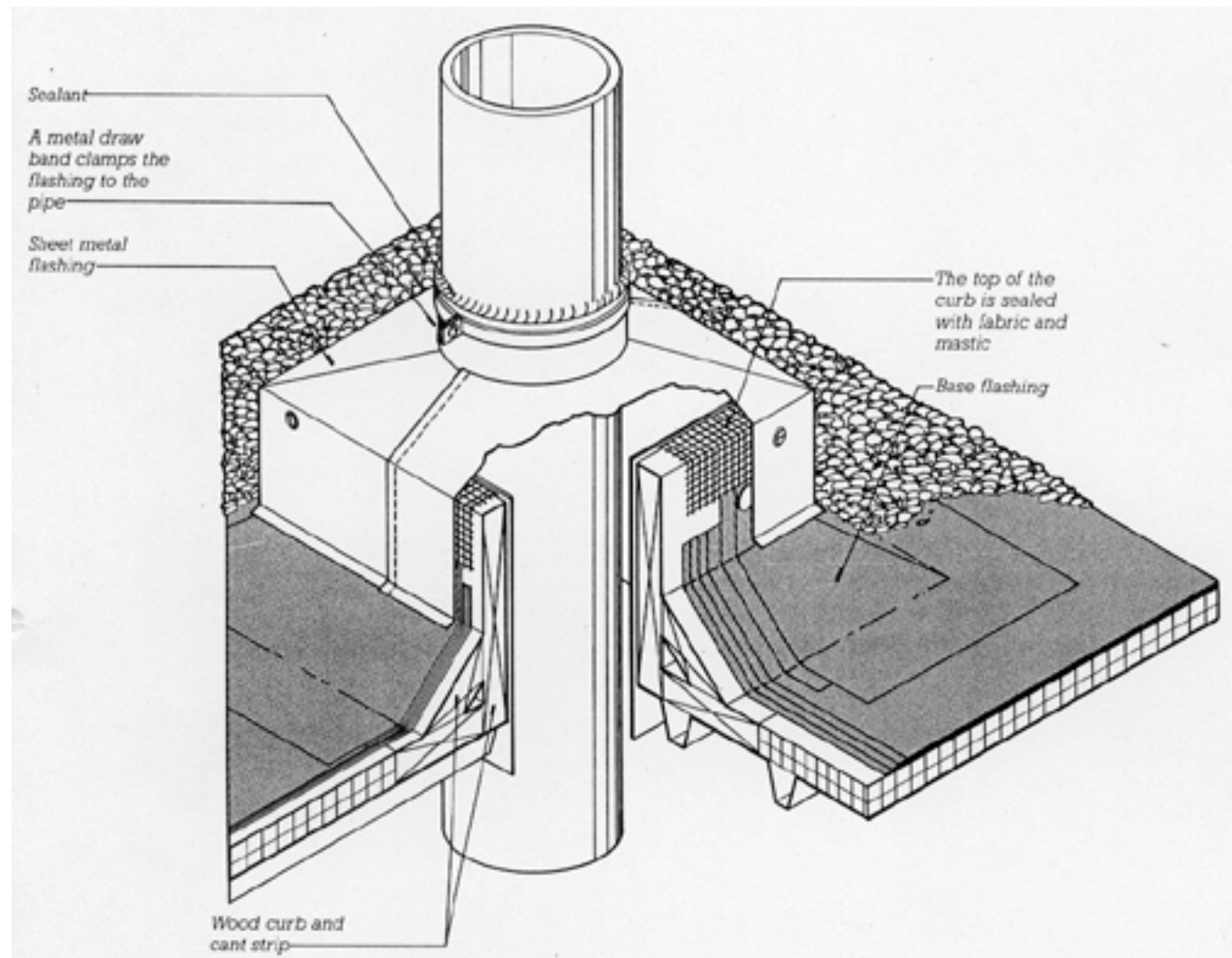
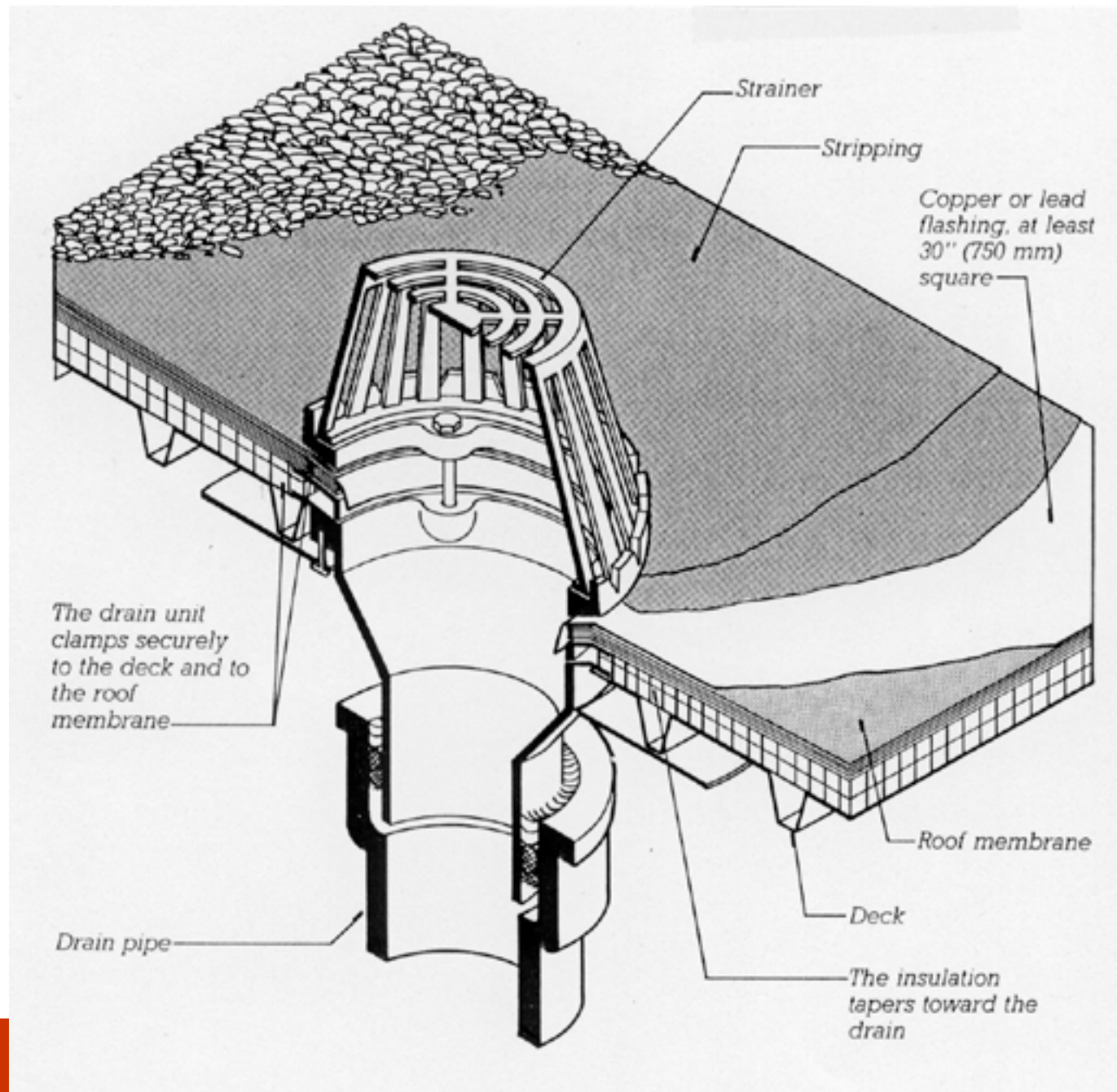

FIGURE 13.33

A roof penetration for a plumbing vent stack. Notice how this and all the previous edge and penetration details for a flat roof use the curb, cant strip, and stripping to keep standing water away from the edge of the membrane.



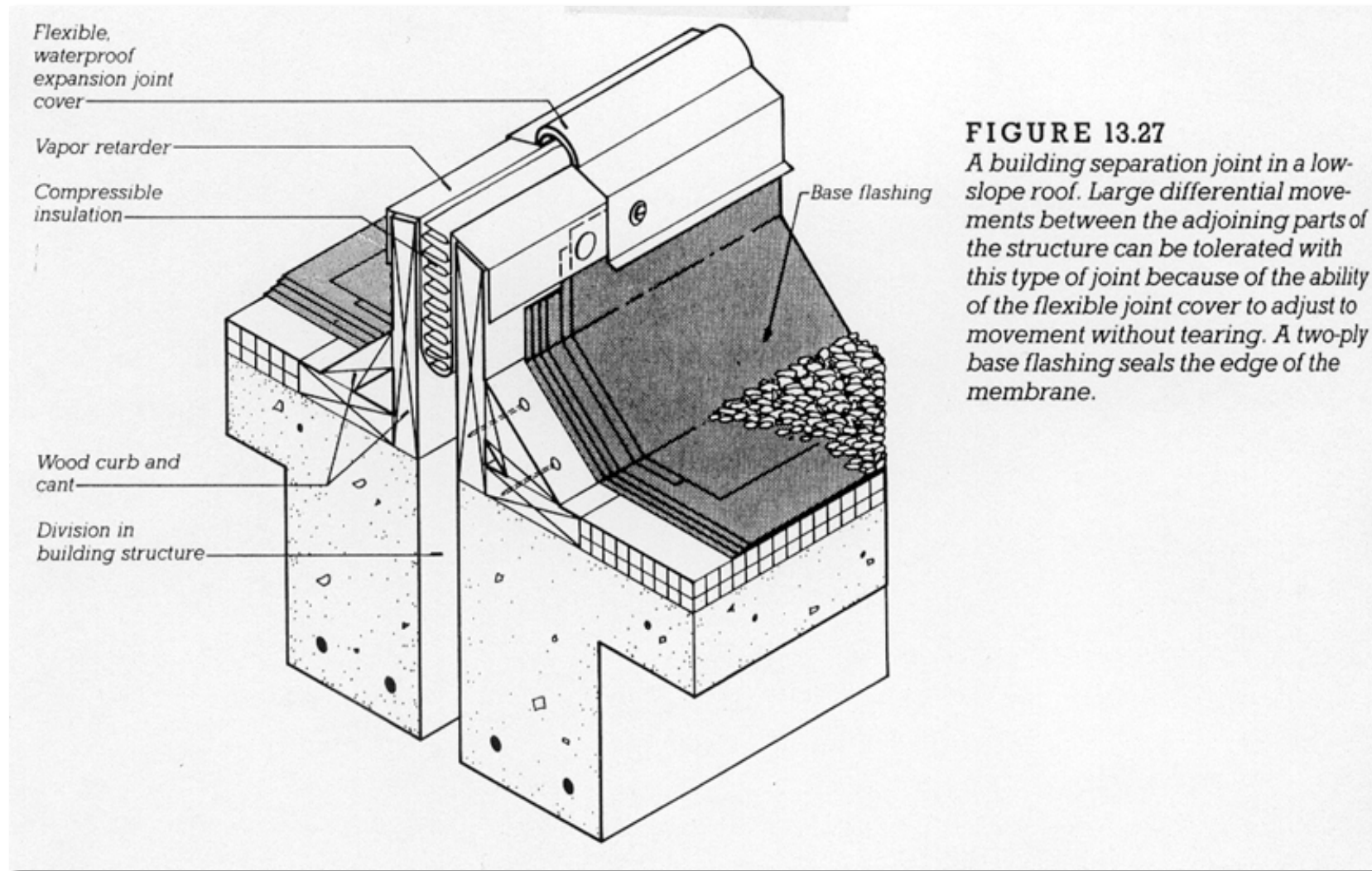
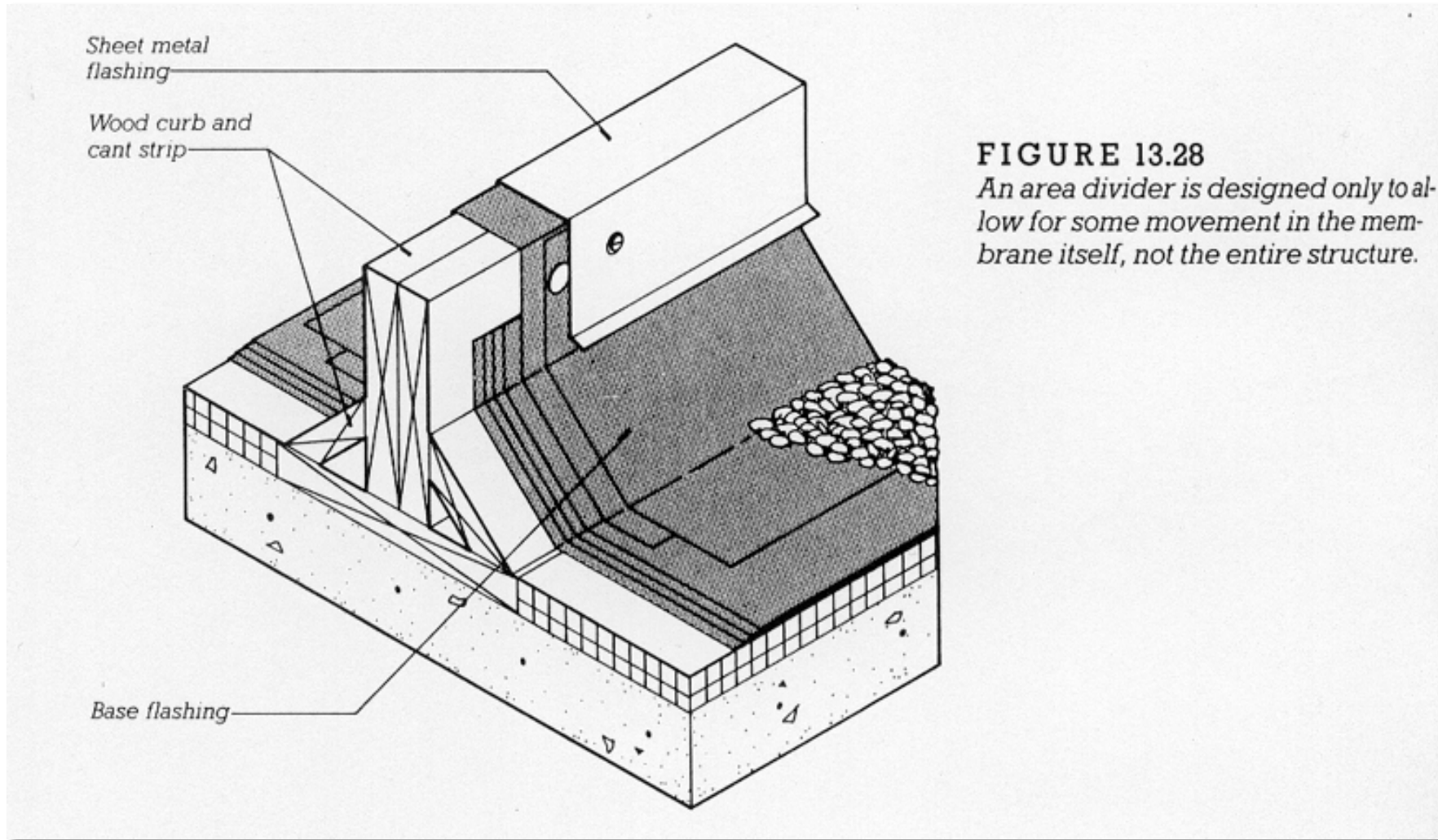

FIGURE 13.27
A building separation joint in a low-slope roof. Large differential movements between the adjoining parts of the structure can be tolerated with this type of joint because of the ability of the flexible joint cover to adjust to movement without tearing. A two-ply base flashing seals the edge of the membrane.

Flat Roof: expansion joint detail



Flat Roof: area divider

